



**VORTICE**

vortice.com



COMMERCIAL VENTILATION 

**CATALOGUE  
IN-LINE FANS**





*Vortice main company's philosophy is the concept that "air is our life". Our mission is always to provide effective solutions for improved air quality using the latest technology to develop and manufacture effective products worldwide.*

Our current Vortice Headquarters have been located in Tribiano (Milan) since 1972.

Vortice has achieved European market leadership by dedicating their efforts to the production of products for ventilation, climate control, heating, extraction, purification and the treatment of air, for domestic, commercial and industrial applications. Since 1954 Vortice has been synonymous with quality and excellence and continues to make significant improvements by investing in continuous research to improve the efficiency and quality of its products.

## VORTICE IN THE WORLD

### ENGLAND



Founded in 1977, Vortice Limited is located at Burton on Trent in the East Midlands.

### CHINA



Founded in 2012, Vortice Ventilation System is located about 200 Km from Shanghai.

### SOUTH AMERICA



Founded in 2012, Vortice Latam in San José, Costa Rica.

# INDEX

<b>LINEO RANGE</b> ..... pag. 04 Vortice Lineo series in-line mixed flow fans	<b>CA WE D E RANGE</b> ..... pag. 46 Painted sheet steel mixed flow duct fans for external wall
<b>LINEO VO RANGE</b> ..... pag. 06 In-line mixed flow fans	<b>CA MD E W RANGE</b> ..... pag. 50 Steel sheet mixed flow wall fans
<b>LINEO VO ES RANGE</b> ..... pag. 20 "Energy Saving" In-line mixed flow fans	<b>CA MD E RF RANGE</b> ..... pag. 56 Painted steel sheet mixed flow roof fans
<b>CA VO RANGE</b> ..... pag. 26 In-line centrifugal fans in self-extinguishing plastic	<b>CA-IN-LINE RANGE</b> ..... pag. 62 Compact flat in-line centrifugal fans
<b>CA MD RANGE</b> ..... pag. 32 In-line centrifugal fans in metal	<b>CA-IN-LINE QUIET RANGE</b> ..... pag. 70 Soundproof compact flat in-line centrifugal fans
<b>CA ES RANGE</b> ..... pag. 40 "Energy Saving" in-line centrifugal fans in metal	<b>CA-IN-LINE QUIET ES RANGE</b> ..... pag. 76 Soundproof compact flat in-line centrifugal EC fans

## CE MARKING

**Commercial Ventilation appliances conform to the following European Directives:**

2009/125/EC Directive Ecocompatible Design (ErP),  
2006/42/EC Machines Directive (MD),  
2004/108/EC Electromagnetic Compatibility Directive (EMC),

According to the following state-of-the-art Standards:

### Safety

EN 60204-1; EN ISO 12100-1; EN ISO 12100-2; EN ISO 12499;  
EN ISO 13857; EN 60335-1; EN 60335-2-80; EN 62233

### Electromagnetic Compatibility

EN 55014-1; EN 55014-2; EN 61000-3-2; EN 61000-3-3

The fans built into the IN LINE Range are conform to the following European Directive N° 1253/2014 and N° 1254/2014.



## LINEO RANGE

Vortice Lineo series in-line mixed flow fans are ideal for duct-mounted ventilation system requiring a good pressure, high air flow and low noise levels

Vortice Lineo fans can be mounted in a wide range of options: at the beginning, middle or end of the air duct and horizontally, vertically, against walls, ceilings, false ceilings or any flat surface. Vortice Lineo range is easy to install and to be removed for inspection and maintenance. Vortice Lineo fans can be fitted to standard round section pipes and to rectangular air ducts (using special mounting accessories). The integrated IP44 rated electrical junction box has an airtight cover. The product is supplied complete with a bag of accessories including anchor bolts and plugs, cable clamps and grommets.



### COMPACT OVERALL DIMENSIONS

The products have a very small overall size, making them ideal for installation in cramped areas. Slim yet powerful, the overall diameter is only slightly larger than the ventilation duct it connects to.

### OVERLOAD PROTECTION

Vortice Lineo models from 100 to 200 are provided with thermal cut-out devices. Lineo models from 250 to 315 are equipped with thermal cut-out, manually resettable.

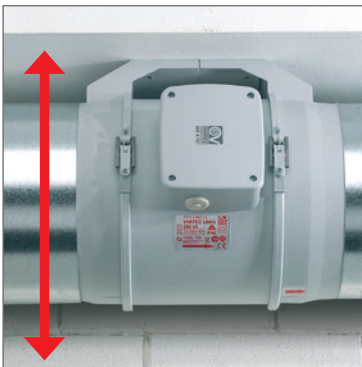

### COMPLIANCE TO STANDARDS

Vortice Lineo range is complying with EN 60335-2-80-1997. Performance conforms to UNI 10531 (Category D). They bear the CE Mark for compliance with the Low Voltage Directive (LVD) and Electromagnetic Compatibility Directive (EMC).

### ENVIRONMENTAL SENSORS

Vortice Lineo fans are capable of advanced functionality in combination with optional sensor units for monitoring humidity, detecting persons, ambient temperature, pollutant levels and air quality.

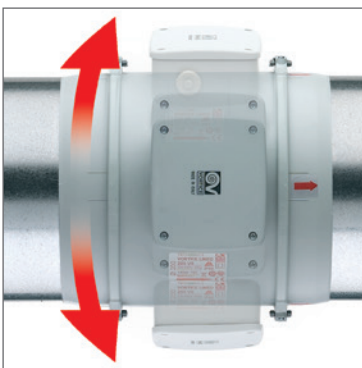





# CONSTRUCTION RANGE



### TIMER

Adjustable timer from 3 to 20 minutes

Protection rating IP44

Hermetic seal

Overload protection

Compact overall dimensions

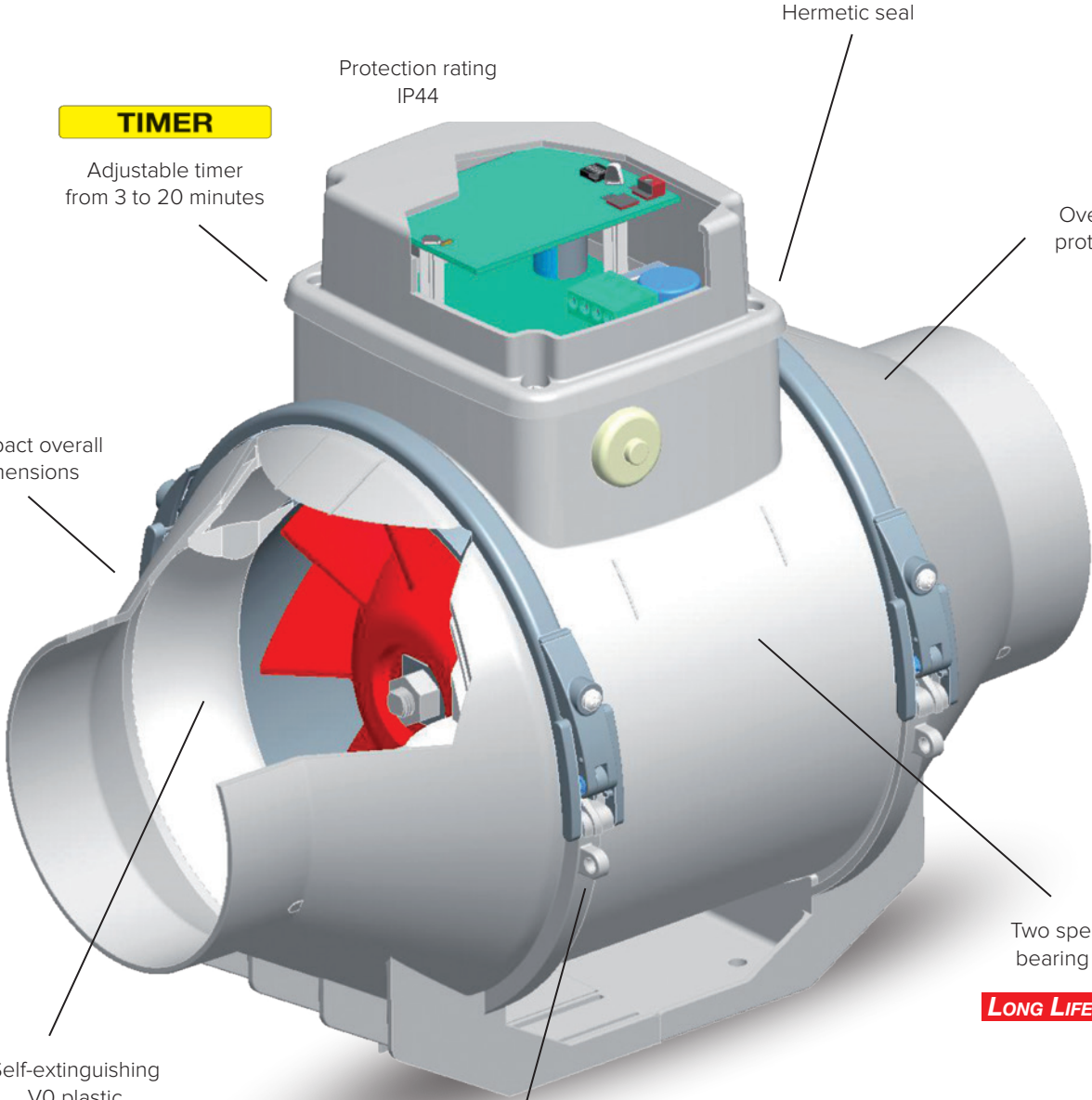

Two speeds ball bearing motors

**LONG LIFE 30.000 h**

Self-extinguishing V0 plastic



Lever closure

## LINEO V0 RANGE

In-line mixed flow fans



2-speed mixed flow duct fans constructed in self-extinguishing plastic resin. Their small radial dimensions make them an effective, space-saving solution for low-visual impact ventilation of residential, commercial or industrial premises (kitchens, toilets, laboratories, bars, restaurants, laundries, shops, etc.).

### VERSIONS

18 models with nominal diameter between 100 and 315 mm, also available in version with timer.

### KEY FEATURES

- Compact overall dimensions, making installation easier even in cramped areas.
- Constructed in self-extinguishing plastic resin (V0) and resistant to aggressive chemical agents.
- Easy installation and maintenance without disconnecting the fan from the extraction and delivery ducts.
- Improved performance through multiple product coupling in series, in parallel or in series and parallel (optional connection kits).
- High protection rating from dust and water for safe use in industrial environments.
- 2-speed motors.
- Can be connected to environmental sensors (optional) to automatically adapt performance to actual requirements.

### TECHNICAL FEATURES

- Motor-holder enclosures, end cones and mixed flow impellers constructed in self-extinguishing plastic resin (V0) with a mineral-based additive to ensure dimensional stability. The side cones incorporate the fan's anchoring brackets onto the target surface for safe, quick installation.
- Elastic devices for fixing the motor-holder to the end cones, built with quick coupling hinges with safety screws for easier cleaning and maintenance.
- Two-speed motors with thermal overload cut-out and shafts turning on ball bearings to guarantee long lasting continuous service (at least 30,000 hat the maximum plate temperature. Speed adjustment using Vortice accessory devices).
- Performance and safety certified by third party body (IMQ).
- Protection rating from dusts and water: IP44 (fan ducted in extraction and delivery).
- Insulation Class: II

### INSTALLATION

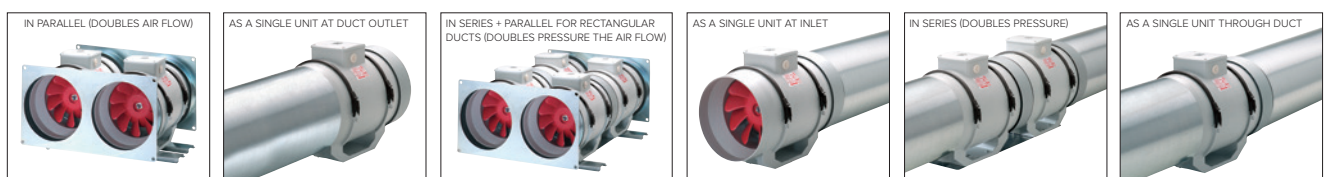

Vortice Lineo extractors can be mounted in a wide range of options - at the beginning, in the middle or at end of air duct and horizontally, vertically, against walls, ceilings, false ceilings on any flat surface. One of the main features is easy inspection and maintenance, in just a few seconds. Vortice Lineo units can be fitted to standard round section pipes and to rectangular air ducts (using unique special mounting accessories).





TECHNICAL DATA

Models	Code		V~50HZ	W min/max	A min/max	RPM min/max	Max Airflow		Max Pressure		LP DB(A) 3m min/max	Max °C	KG
	BASIC	TIMER					m³/h min/max	l/s min/max	mmH <sub>2</sub> O min/max	Pa min/max			
LINEO 100 V0	17001	17021	220-240	20 23	0.09 0.11	1520 2030	180 255	50.0 70.8	13.0 16.5	127.5 161.9	30.7 39.4	60	1.80
LINEO 100 Q V0	17005	17025	220-240	12 15	0.05 0.07	1860 2450	155 200	43.1 55.6	6.5 7.5	63.8 73.6	29.4 37.9	60	1.25
LINEO 125 V0	17002	17022	220-240	25 33	0.11 0.15	1570 2140	250 365	69.4 101.4	13.0 17.0	127.5 166.8	33.9 43.0	60	1.80
LINEO 150 V0	17003	17023	220-240	40 58	0.18 0.26	1580 2100	385 550	106.9 152.8	21.0 27.0	206.0 264.9	41.4 50.5	60	2.40
LINEO 160 V0	17004	17024	220-240	40 58	0.18 0.26	1580 2100	385 550	106.9 152.8	21.0 27.0	206.0 264.9	41.7 50.8	60	2.40
LINEO 200 Q V0	17007	17028	220-240	45 75	0.22 0.37	1780 2740	700 950	194.4 263.9	13.0 29.0	127.5 284.5	39.6 49.0	60	3.70
LINEO 200 V0	17006	17026	220-240	98 145	0.43 0.64	1580 2140	790 1060	219.4 294.4	29 33	284.5 323.7	46.2 52.5	60	4.3
LINEO 250 Q V0	17027	17029	220-240	85 110	0.40 0.50	1850 2550	720 990	200.0 275.0	34.0 53.0	333.5 519.9	49.1 56.2	60	5.80
LINEO 250 V0	17009	-	220-240	110 180	0.48 0.78	1900 2550	990 1350	275 375	36 53	353.5 519.9	51.4 59.1	60	5.80
LINEO 315 V0	17010	-	220-240	200 300	0.90 1.32	1780 3450	1740 2300	483.3 638.9	43.5 75	426.7 735.8	50.6 63.4	60	11.30

DIMENSIONS

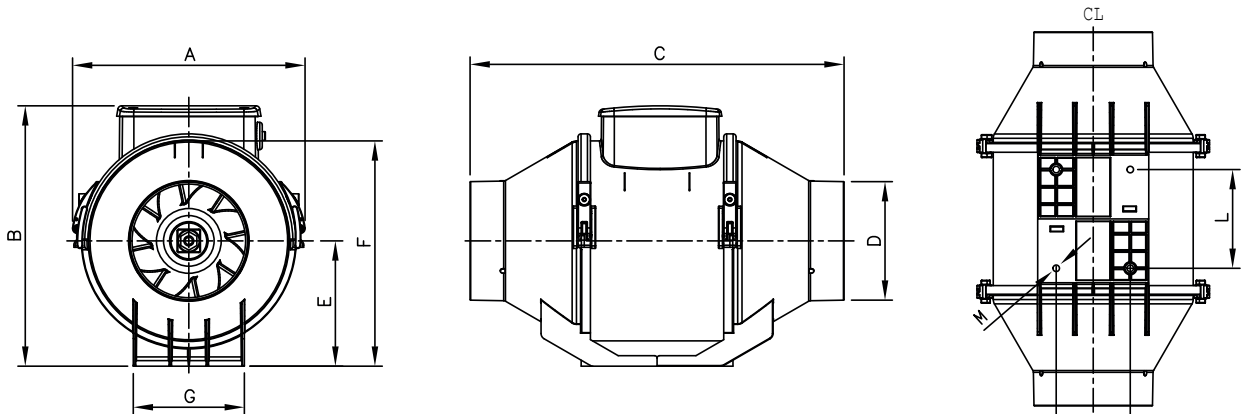

MODELS	ØA	B	C	ØD	E	F	G	H	L	M
LINEO 100 V0	188.5	211	303	96	101.5	189	90	60	80	6
LINEO 100 Q V0	156	174	231	96	82	152	95	51.5	47.5	6
LINEO 125 V0	188.5	211	258	122	101.5	189	90	60	80	6
LINEO 150 V0	214.5	234	294	146	112.5	212	110	60	80	6
LINEO 160 V0	214.5	234	272.5	156	112.5	212	110	60	80	6
LINEO 200 Q V0	234.5	260.5	300	196	125.5	235	140	94	100	6
LINEO 200 V0	234.5	260.5	300	196	125.5	235	140	94	100	6
LINEO 250 Q V0	300	317	385	247	152.5	292	176.5	140	145	8
LINEO 250 V0	300	317	385	247	152.5	292	176.5	140	145	8
LINEO 315 V0	361.5	392.5	448	312	188.5	359	220.5	178	182	8

Dimensions (mm)



# COMMERCIAL VENTILATION

## LINEO V0 RANGE

### PERFORMANCES CURVES

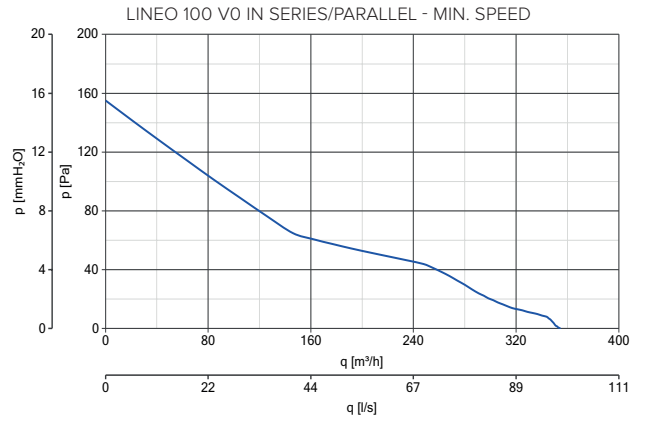
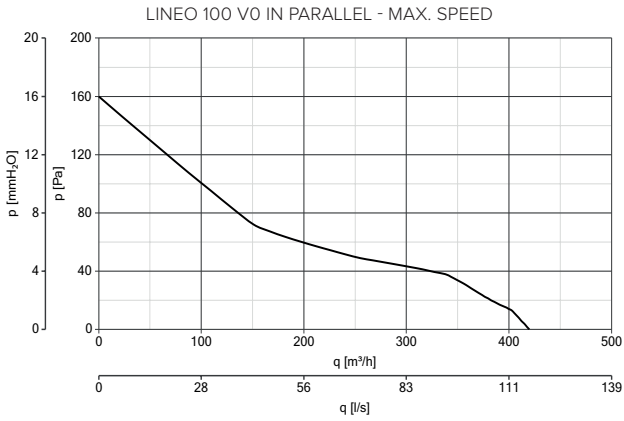
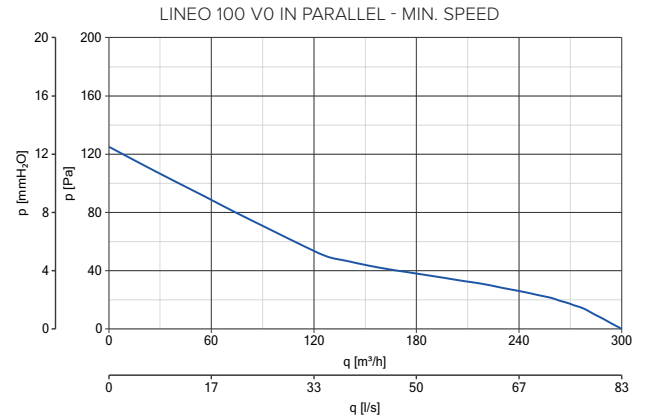
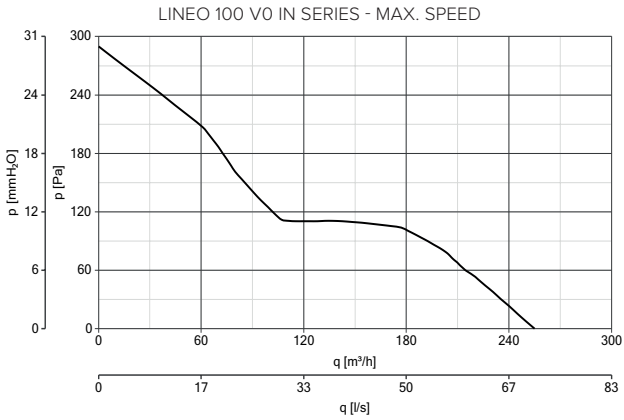
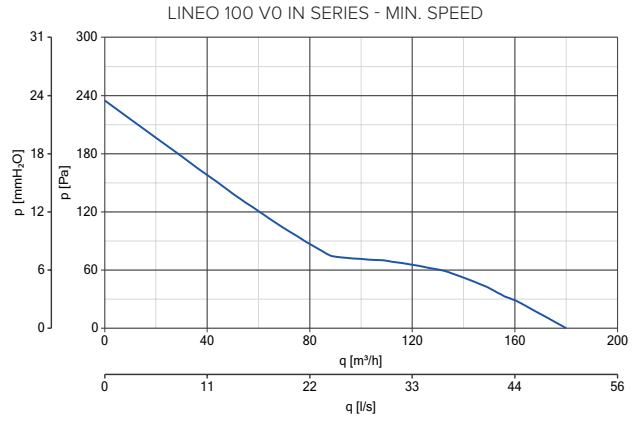
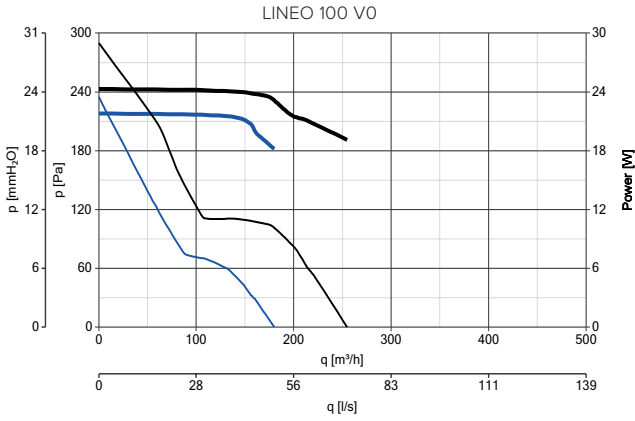

POWER CONSUMPTION      PERFORMANCES CURVES  
 — max                      — max  
 — min                      — min





PERFORMANCES CURVES

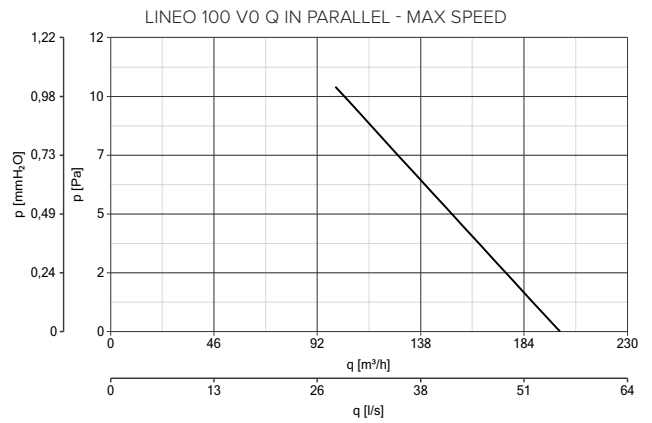
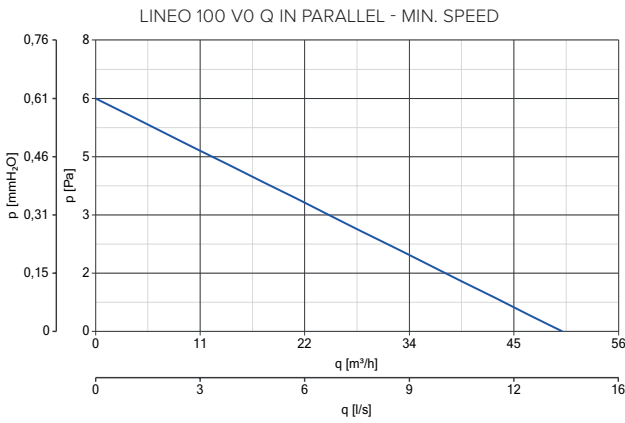
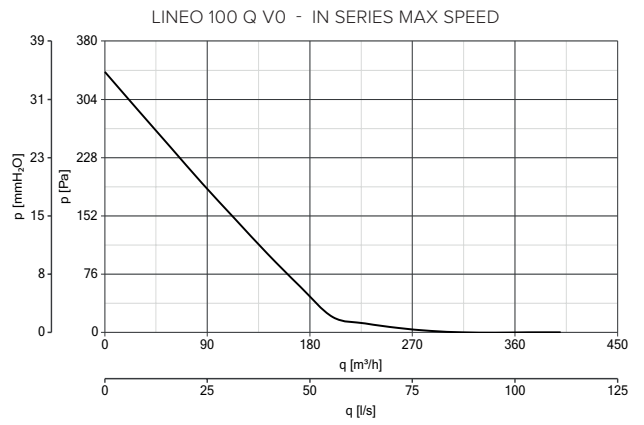
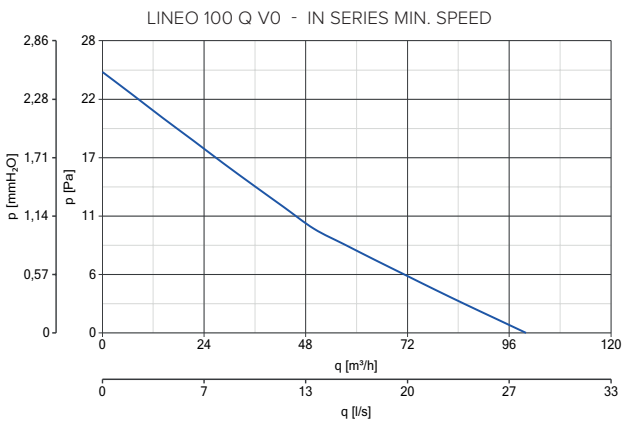
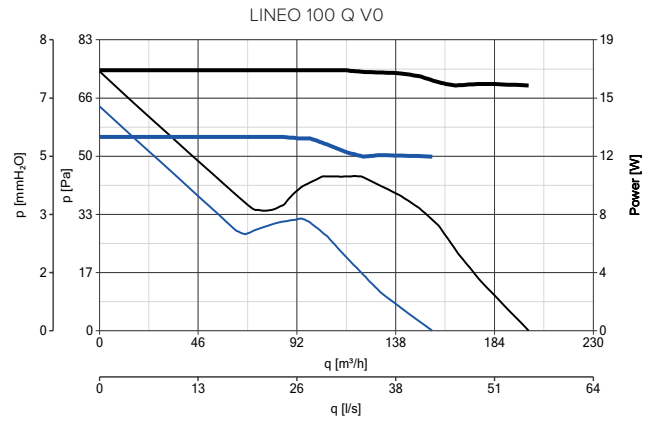
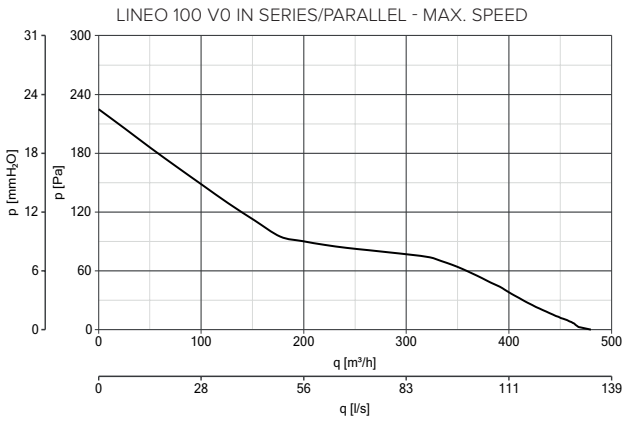

POWER CONSUMPTION PERFORMANCES CURVES  
 — max — max  
 — min — min



PERFORMANCES CURVES

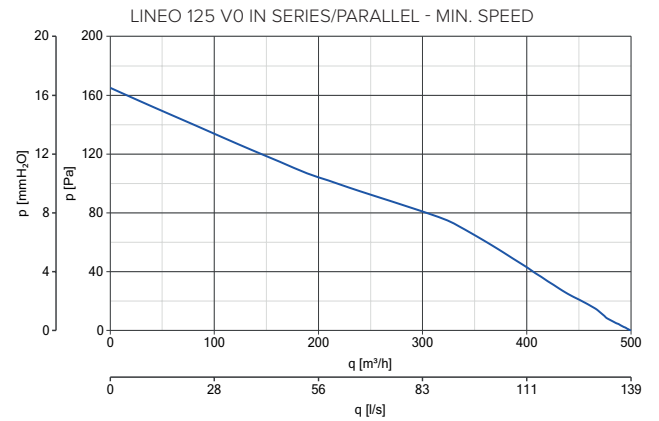
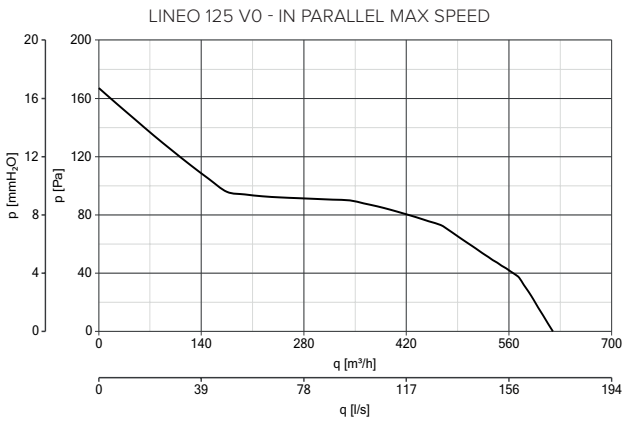
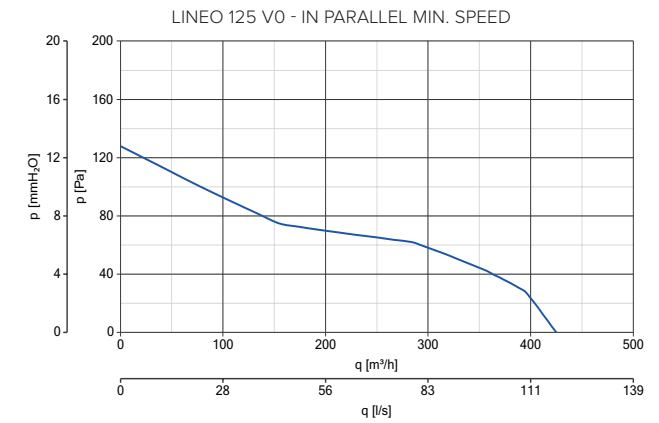
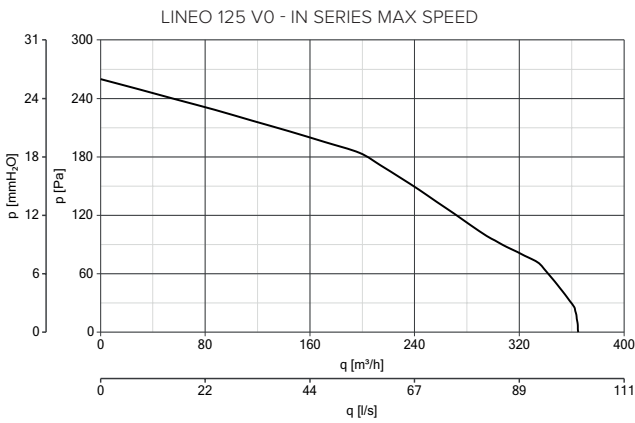
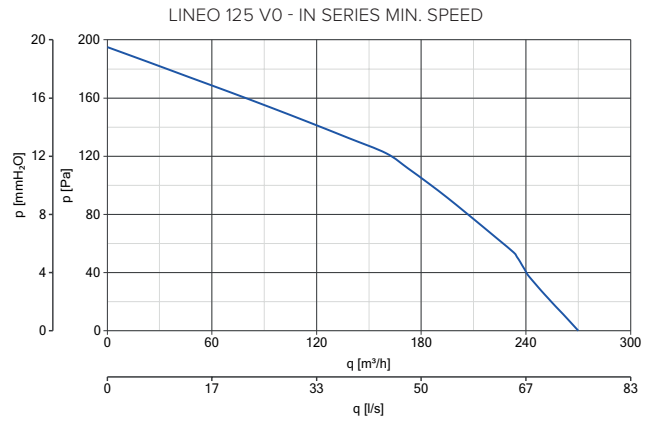
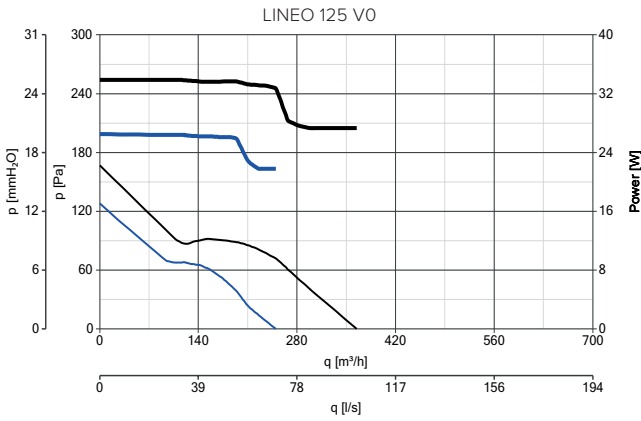

POWER CONSUMPTION      PERFORMANCES CURVES  
 — max                      — max  
 — min                      — min





PERFORMANCES CURVES

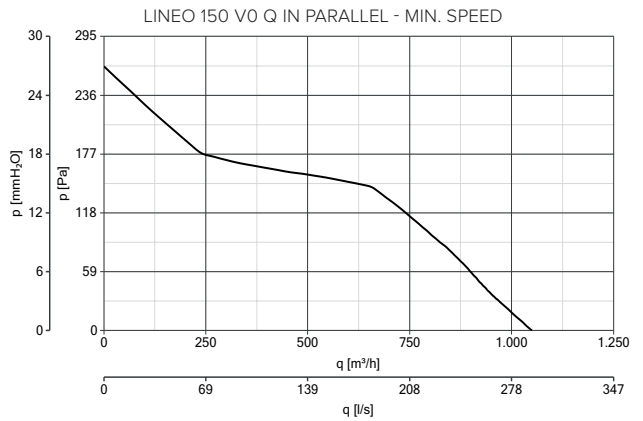
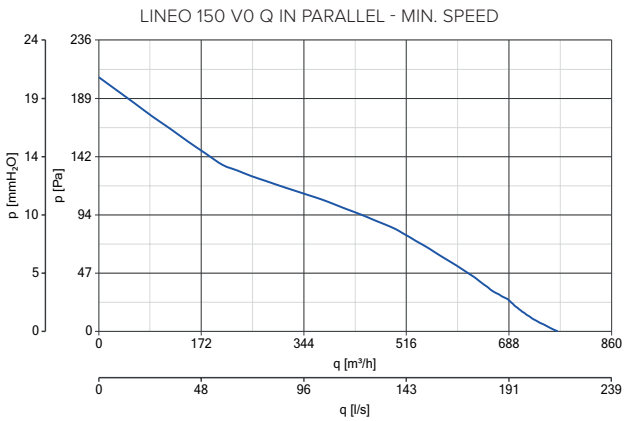
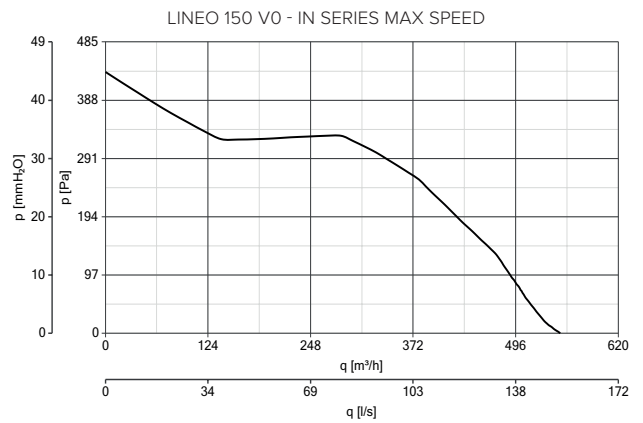
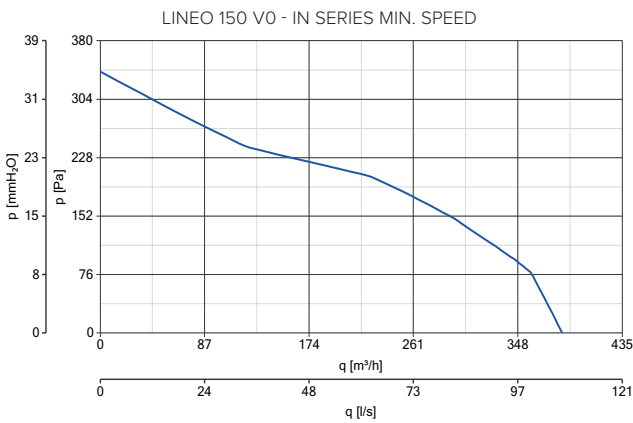
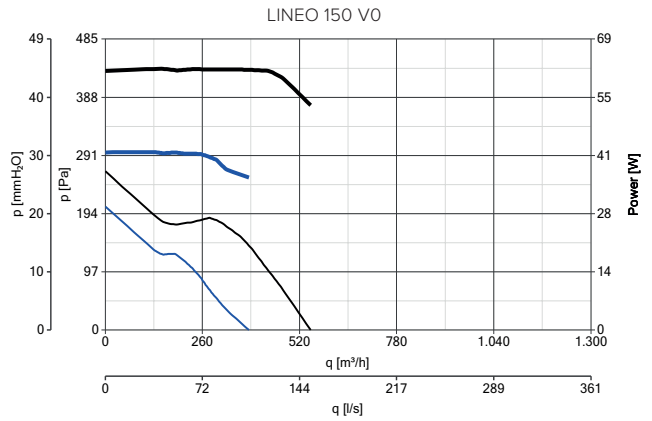
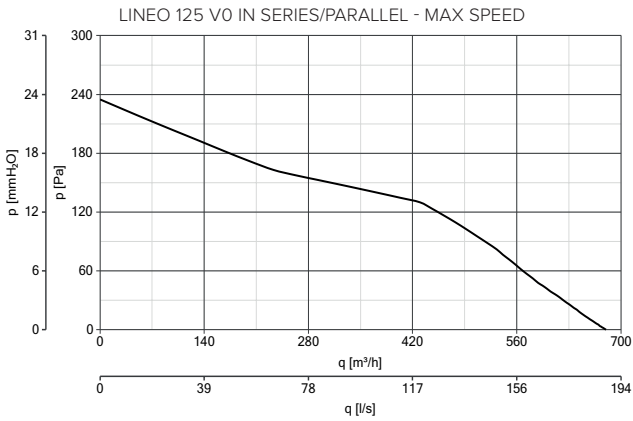

POWER CONSUMPTION PERFORMANCES CURVES  
 — max — max  
 — min — min



# COMMERCIAL VENTILATION

## LINEO V0 RANGE

### PERFORMANCES CURVES

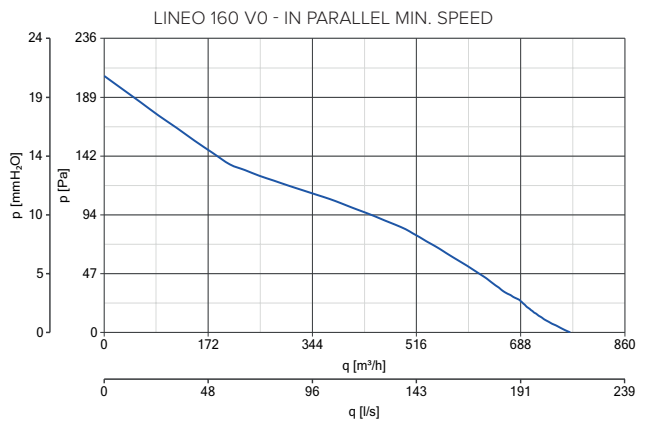
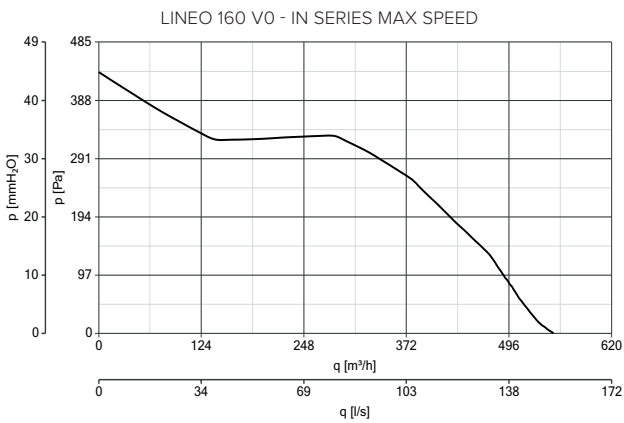
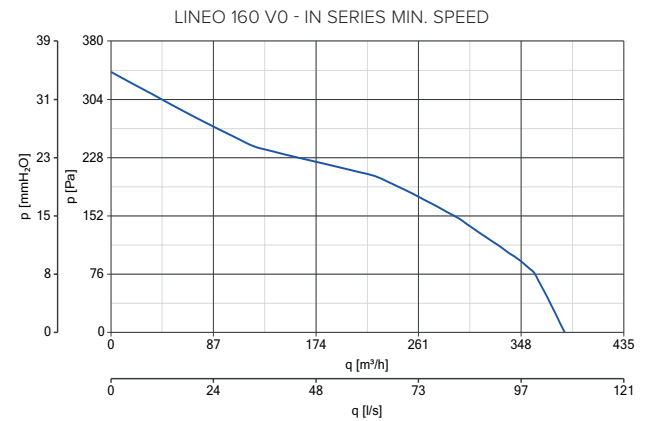
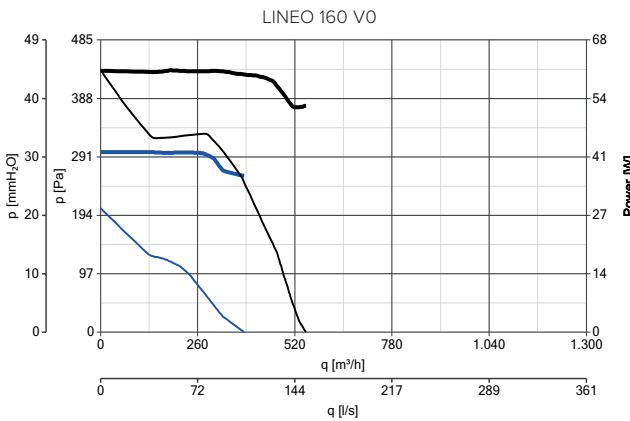
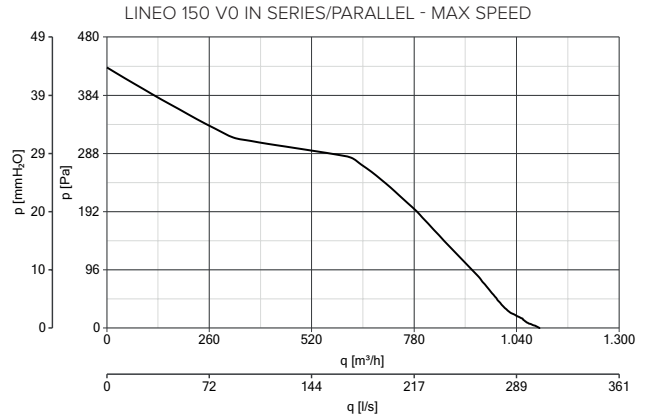
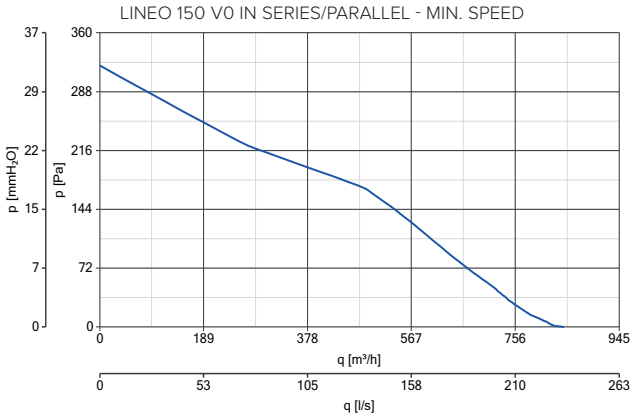

POWER CONSUMPTION      PERFORMANCES CURVES  
 — max                      — max  
 — min                      — min



PERFORMANCES CURVES

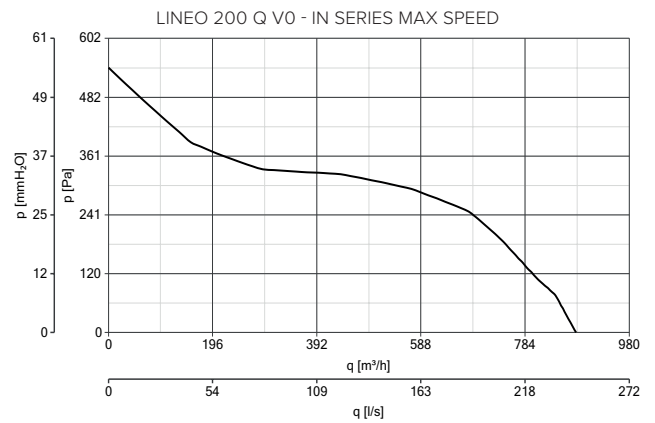
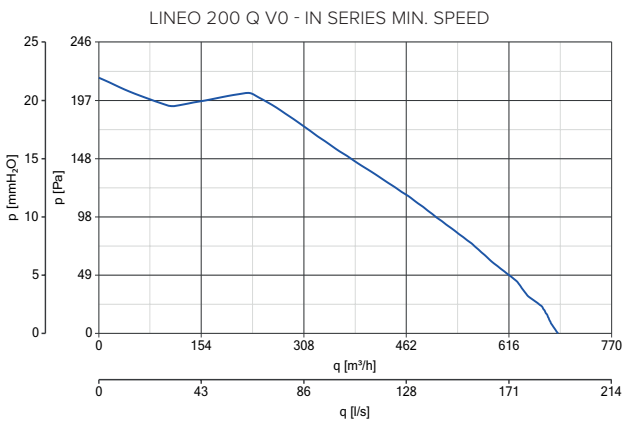
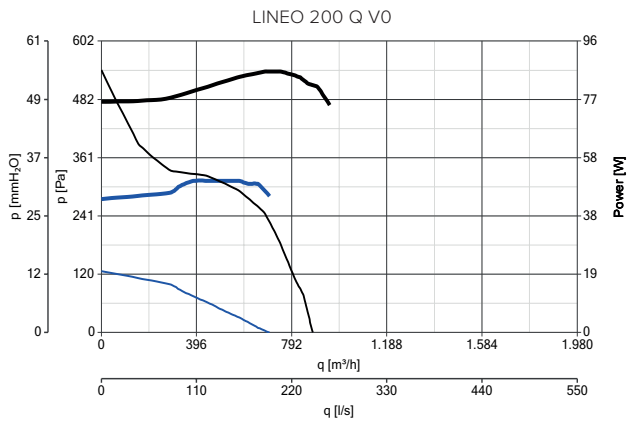
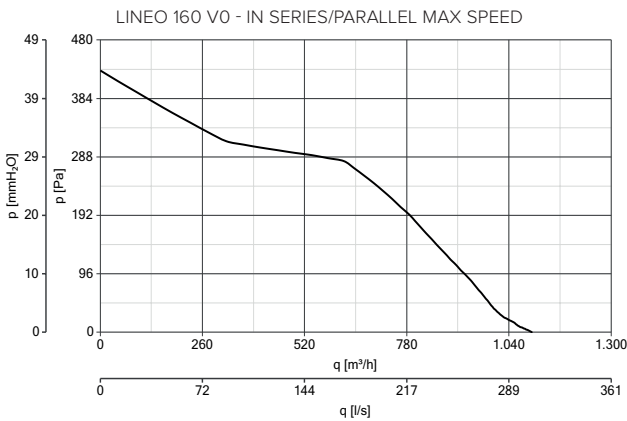
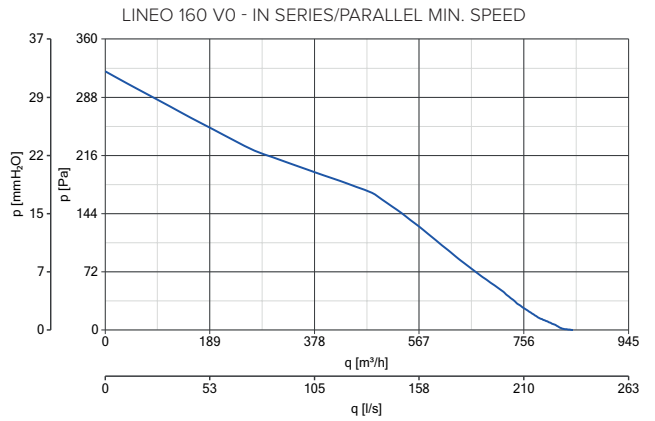
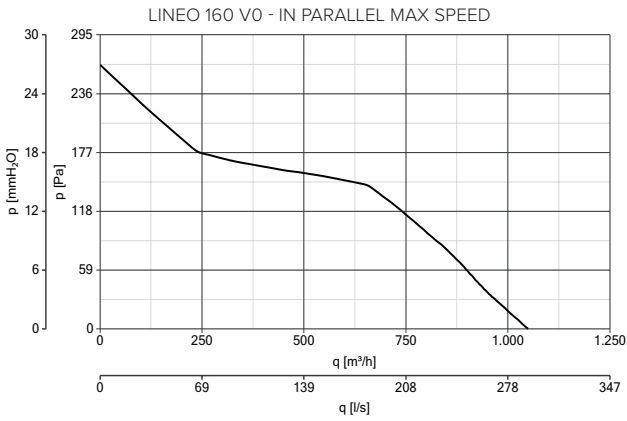

POWER CONSUMPTION      PERFORMANCES CURVES  
 — max                      — max  
 — min                      — min





# COMMERCIAL VENTILATION

LINEO V0 RANGE

## PERFORMANCES CURVES

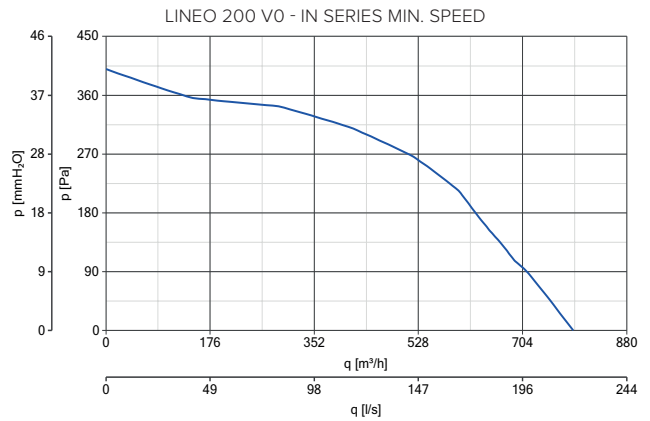
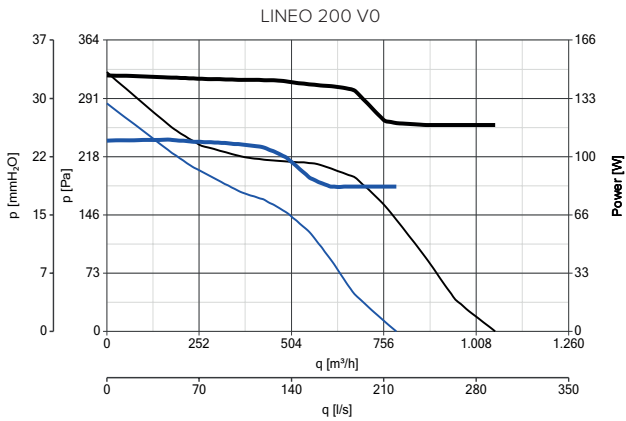
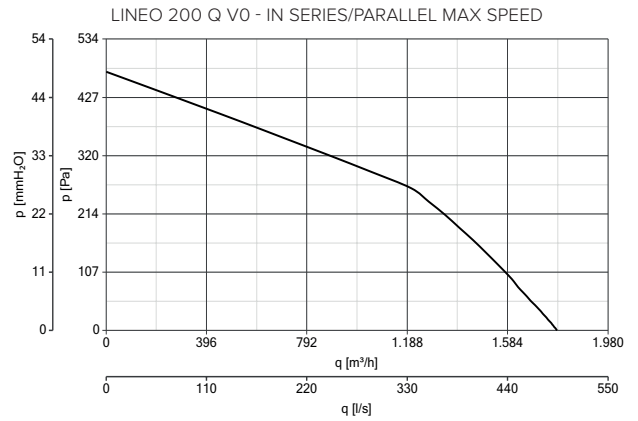
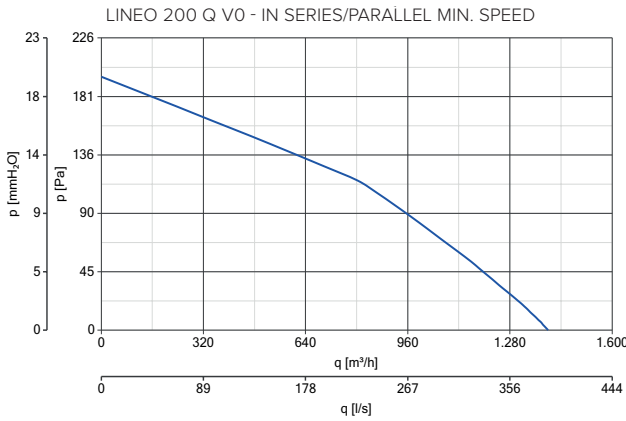
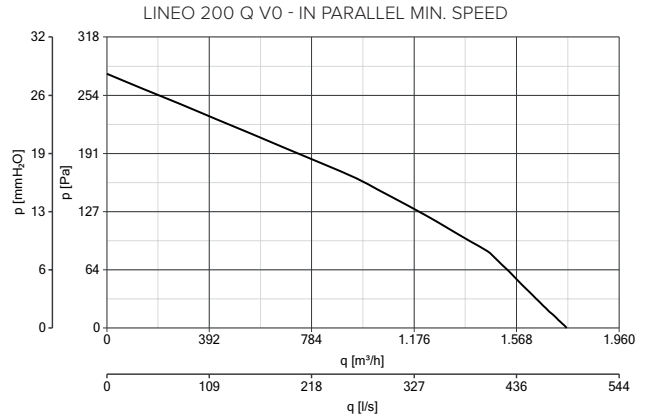
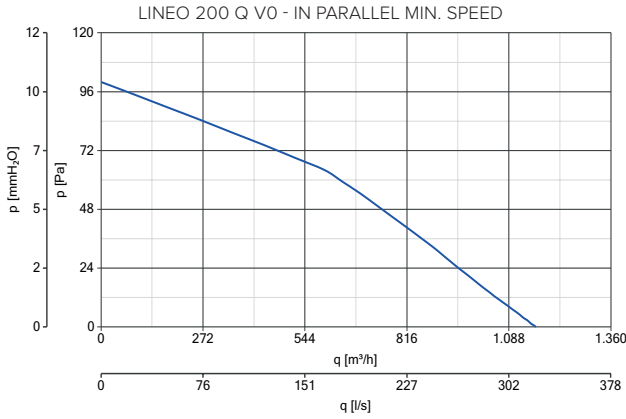

POWER CONSUMPTION      PERFORMANCES CURVES  
 — max                      — max  
 — min                      — min



PERFORMANCES CURVES

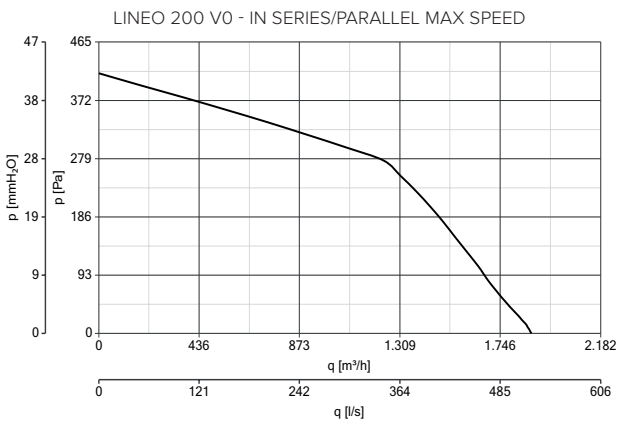
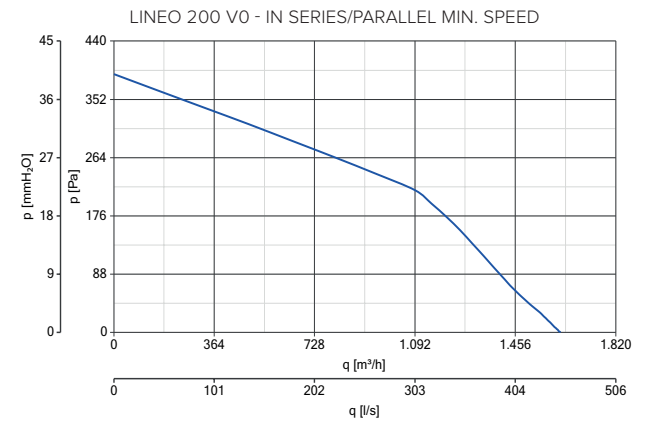
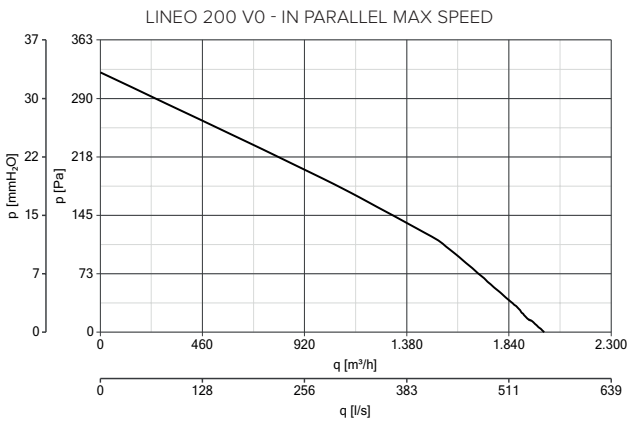
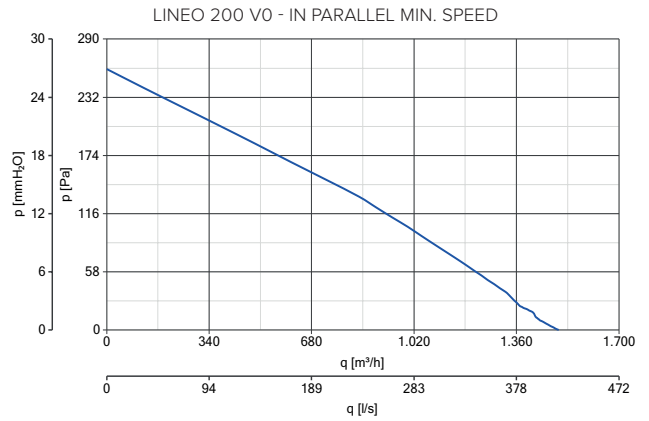
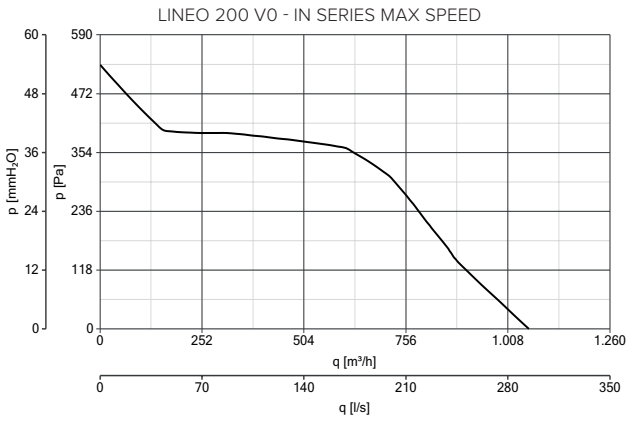

POWER CONSUMPTION PERFORMANCES CURVES

— max — max  
 — min — min



PERFORMANCES CURVES

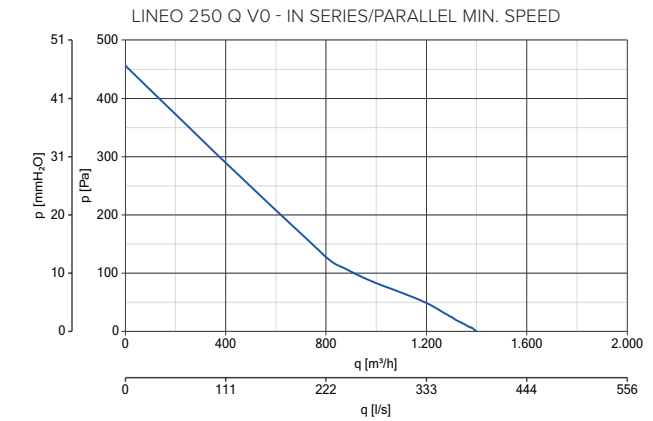
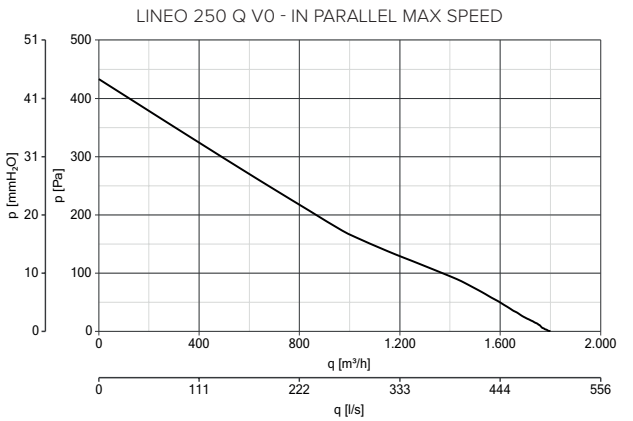
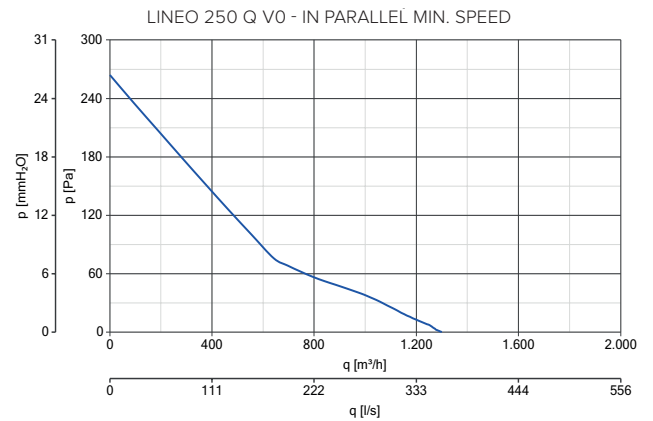
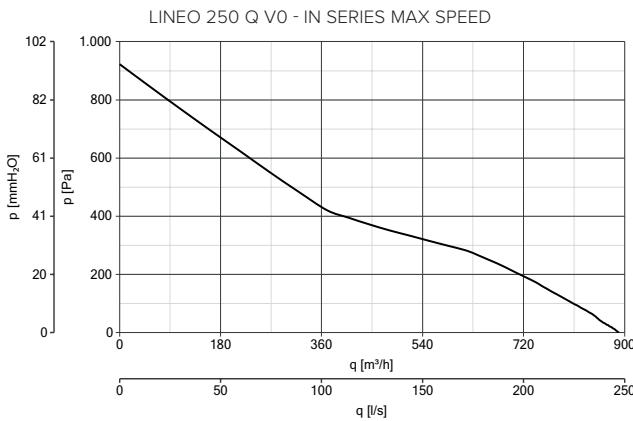
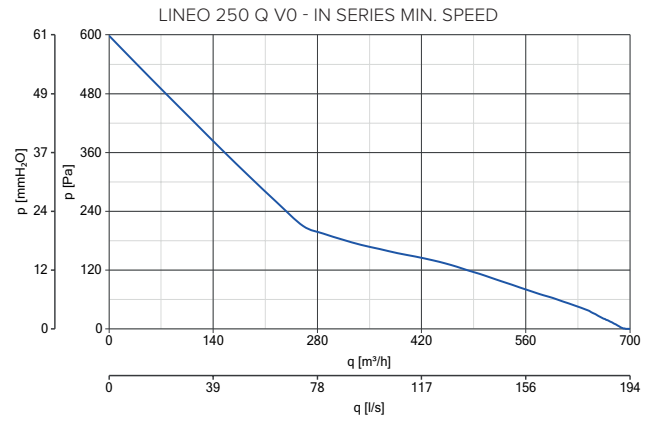
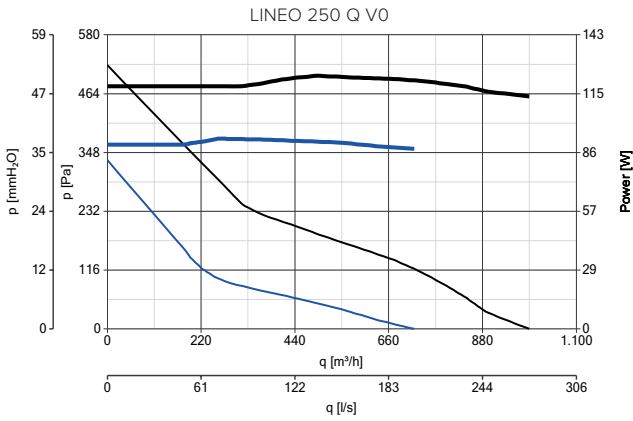

POWER CONSUMPTION      PERFORMANCES CURVES  
 — max                      — max  
 — min                      — min



PERFORMANCES CURVES

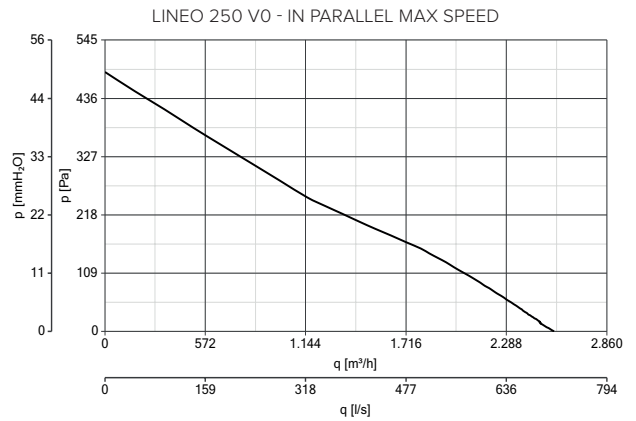
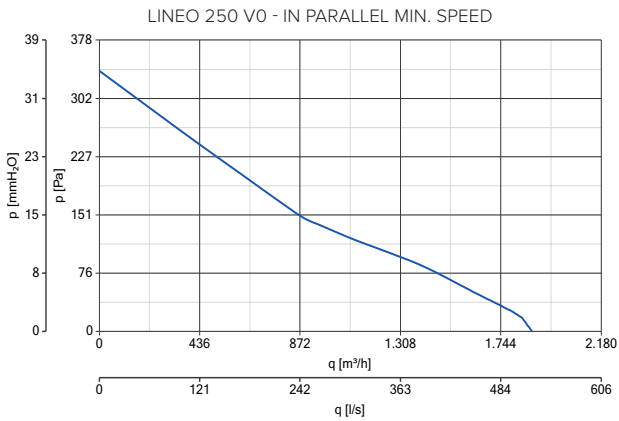
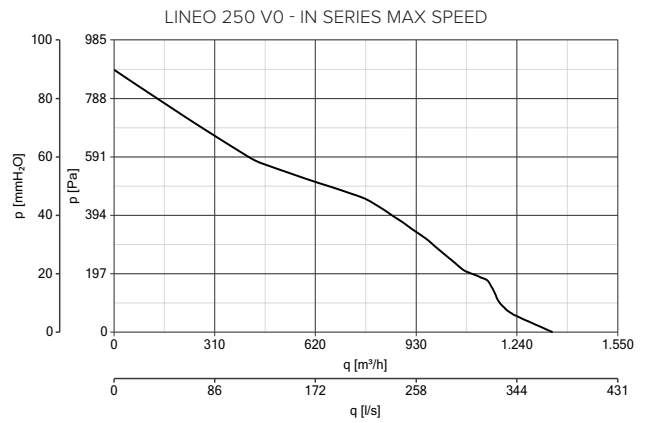
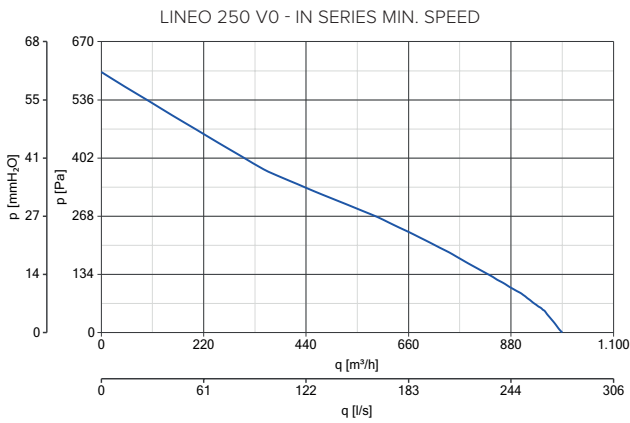
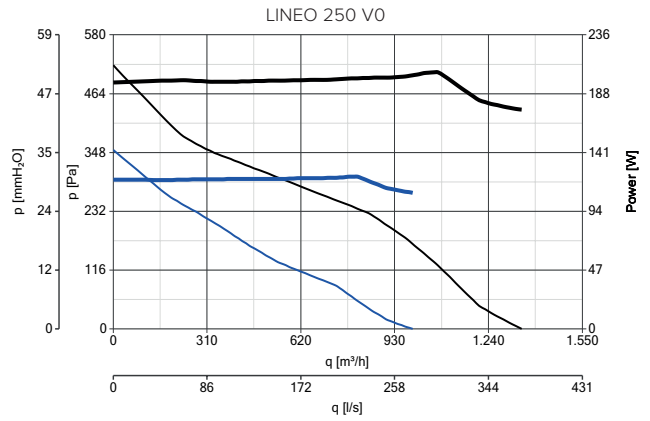
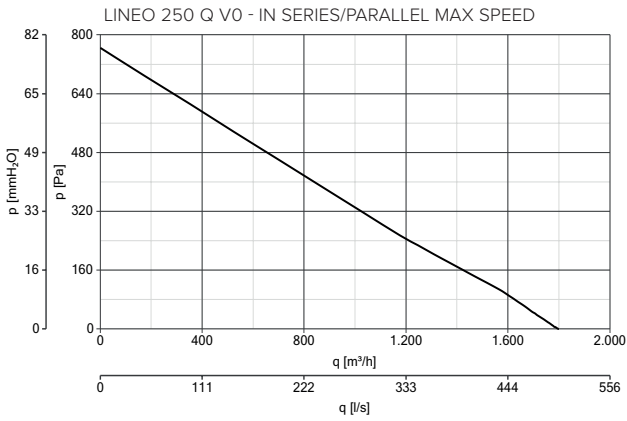

POWER CONSUMPTION PERFORMANCES CURVES  
 — max — max  
 — min — min







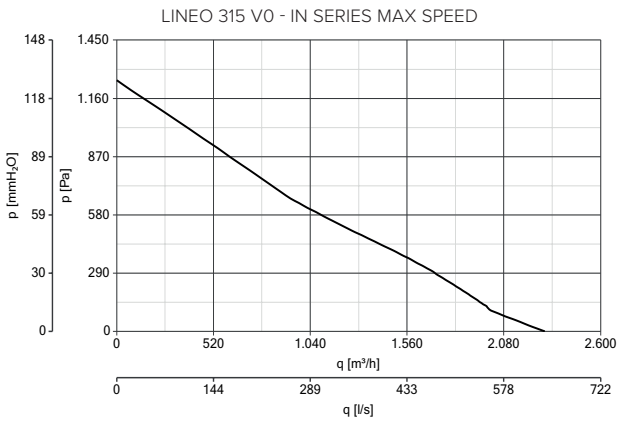
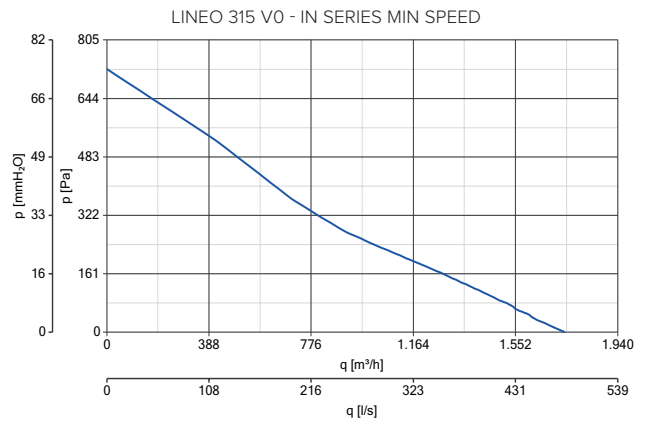
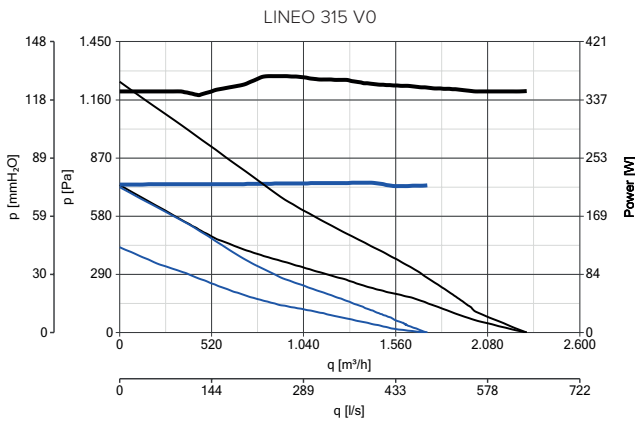
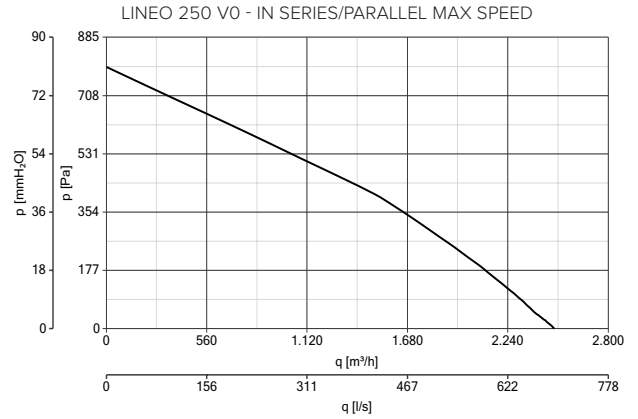
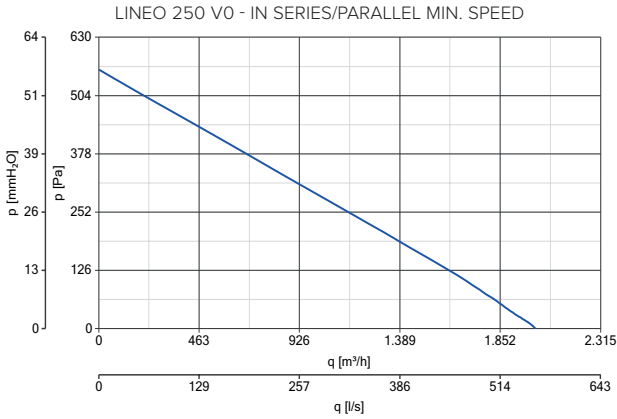

PERFORMANCES CURVES





POWER CONSUMPTION PERFORMANCES CURVES  
 — max — max  
 — min — min



**CONTROLLERS**

MODELS	DESCRIPTION	CODE	PRODUCT
	<b>C5 0.5</b> - 5 SPEED CONTROLLER	12987	17001 - 17021 - 17005 - 17025 - 17002 17022 - 17003 - 17023 - 17004 - 17024
	<b>C 1.5</b> - ELECTRONIC SPEED CONTROLLER 1.5 A	12966	17001 - 17021 - 17005 - 17025 - 17002 17022 - 17003 - 17023 - 17004 - 17024 17007 - 17028
	<b>C 2.5</b> - ELECTRONIC SPEED CONTROLLER 2.5 A	12967	17027 - 17029
	<b>KIT SCB5</b> - CONVERTS SCR5 TO A BUILT-IN VERSION	22483	12987
	<b>KIT SCB</b> - BUILT-IN CONTROLLER ADAPTOR	22481	12966 - 12967
	<b>DUO</b> - 2 SPEEDS CONTROLLER	22914	ALL PRODUCTS
	<b>C TEMP</b> - THERMO SWITCH	12992	ALL PRODUCTS
	<b>C SMOKE</b> - AIR QUALITY SENSOR	12993	ALL PRODUCTS
	<b>C HCS</b> - HUMIDISTAT	12994	ALL PRODUCTS
	<b>C PIR</b> - PASSIVE INFRARED SENSOR	12998	ALL PRODUCTS
	<b>C TIMER</b> - TIMER	12999	ALL PRODUCTS

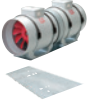
**ACCESSORIES ON REQUEST**

MODELS	DESCRIPTION	CODE	PRODUCT
	<b>LINEO-C</b> - SERIES INSTALLATION KIT	100	22584 17001 - 17021
		125	22585 17002 - 17022
		150	22586 17003 - 17023
		160	22587 17004 - 17024
		200	22588 17007 - 17028
		250	22589 17027 - 17029
		315	22592 17010
	<b>LINEO-SF</b> - BRACKET FOR SERIES APPLICATION	500	22593 17001 - 17021 - 17002 - 17022 - 17003 17023 - 17004 - 17024 - 17007 - 17028
		700	22594 17027 - 17029
	<b>LINEO-PF</b> - PARALLEL INSTALLATION KIT	100	22577 17001 - 17021
		125	22578 17002 - 17022
		150	22579 17003 - 17023
		160	22581 17004 - 17024
		200	22582 17007 - 17028
	<b>LINEO-G</b> - PROTECTION GRILLE	250	22583 17027 - 17029
		100	22701 17001 - 17021 - 17005 - 17025
		125	22702 17002 - 17022
		150	22703 17003 - 17023
		160	22704 17004 - 17024
		200	22705 17007 - 17028
		250	22706 17027 - 17029
315	22707 17010		



**LONG LIFE 80.000 h**



## LINEO V0 ES RANGE

“Energy Saving” In-line mixed flow fans

Mixed flow duct fans constructed in self-extinguishing plastic resin, driven by 2-speed EC motors (brushless). Their small radial dimensions make them an effective, effective space-saving solution for low-visual impact ventilation of residential, commercial or industrial premises (kitchens, toilets, laboratories, bars, restaurants, laundries, shops, etc.).

### VERSIONS

7 models, with nominal diameter between 100 and 315 mm.

### KEY FEATURES

- High efficiency EC (brushless) motors that are continuously adjustable (0-10V signal) or are settable at installation for 2-speed operation.
- Compact overall dimensions, making installation easier even in cramped areas.
- Constructed in self-extinguishing plastic resin (V0) and resistant to aggressive chemical agents.
- Easy installation and maintenance without disconnecting the fan from the extraction and delivery ducts.
- High protection rating from dust and water for safe use in industrial environments.
- Can be connected to environmental sensors (optional) to automatically adapt performance to actual requirements.

### TECHNICAL FEATURES

- Motor-holder enclosures, end cones and mixed flow impellers constructed in self-extinguishing plastic resin (V0) with a mineral-based additive to ensure dimensional stability. The side cones incorporate the fan's anchoring brackets onto the target surface for safe, quick installation.
- Elastic devices for fixing the motor-holder to the end cones, built with quick coupling hinges with safety screws for easier cleaning and maintenance.
- Two-speed EC (brushless) motors with thermal overload cut-out and shafts turning on ball bearings to guarantee long lasting (at least 40,000 h) continuous service at the maximum plate temperature. Possibility of continuous speed adjustment through potentiometers (0-10V signal).
- Protection rating from dusts and water: IP44 (fan ducted in extraction and delivery).
- Insulation Class: II .



TECHNICAL DATA

Models	Code	V~50HZ	W			Max Airflow		Max Pressure		LP DB(A) 3m min/max	Max °C	KG	
			min	max	A min/max	RPM min/max	m³/h min/max	l/s min/max	mmH <sub>2</sub> O min/max				Pa min/max
LINEO 100 V0 ES	17150	220-240	3	20	0.05 0.20	300 2300	24 280	7 78	0.2 26.0	2 255	40.8	60	1.9
LINEO 125 V0 ES	17152	220-240	3	25	0.05 0.25	300 2350	35 360	10 100	0.2 31.0	2 304	44.4	60	1.8
LINEO 150 V0 ES	17153	220-240	3	55	0.05 0.50	300 2550	50 600	14 167	0.3 50.0	3 490	53.2	60	2.2
LINEO 160 V0 ES	17154	220-240	3	60	0.05 0.55	300 2650	55 620	15 172	0.3 50.0	3 490	54.1	60	2.1
LINEO 200 V0 ES	17155	220-240	3	80	0.05 0.75	300 3100	77 1000	21 278	0.3 34.0	3 333	47.5	60	2.5
LINEO 250 V0 ES	17156	220-240	3	124	0.05 1.00	300 3000	85 1100	24 306	0.7 60	7 588	57.3	50	5.3
LINEO 315 V0 ES	17157	220-240	5	240	0.05 1.5	300 2350	205 1805	57 514	1.1 68	11 667	64.9	50	9.5

TECHNICAL DATA FOR REGULATION N° 327/2011/UE (11, 1ST TIER)

Models	Code	Maesurement Cat.	Efficiency Cat.	Year of construction	Variable Drive	η	N.	BEP*				
								Pe kW	q m³/h	p Pa	RPM	Spec. ratio <1.04
LINEO 315 V0 ES	17157	C	STATIC	2016	YES	36.7	53.3	0.262	1050	291.36	2350	YES

\* Best efficiency point

DIMENSIONS

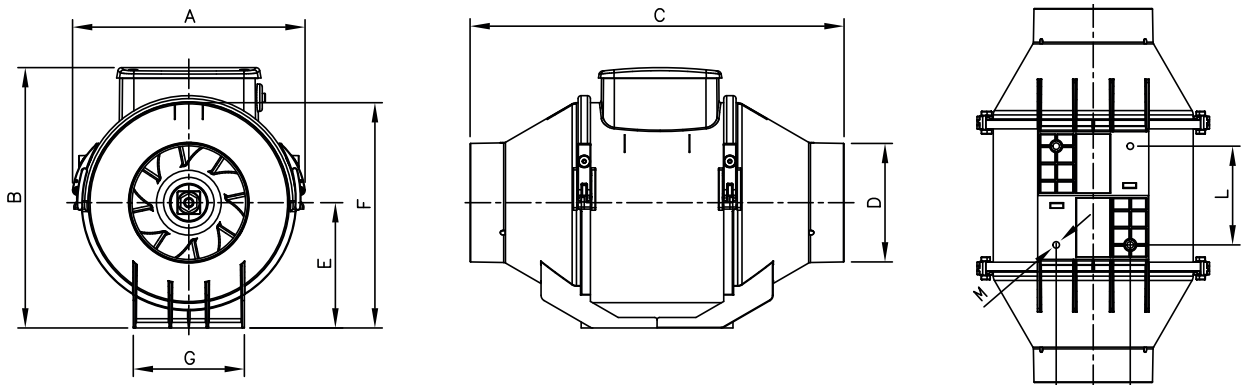

MODELS	ØA	B	C	ØD	E	F	G	H	L	M
LINEO 100 V0 ES	188.5	240	303	96	101.5	189	90	60	80	6
LINEO 125 V0 ES	188.5	240	258	122	101.5	189	90	60	80	6
LINEO 150 V0 ES	214.5	265	294	146	112.5	212	110	60	80	6
LINEO 160 V0 ES	214.5	265	272.5	156	112.5	212	110	60	80	6
LINEO 200 V0 ES	234.5	290	300	196	125.5	235	140	94	100	6
LINEO 250 V0 ES	300	350	385	247	125.5	292	176.5	140	145	6
LINEO 315 V0 ES	361.5	460	448	312	188.5	359	220.5	178	182	6

Dimensions (mm)





PERFORMANCES CURVES

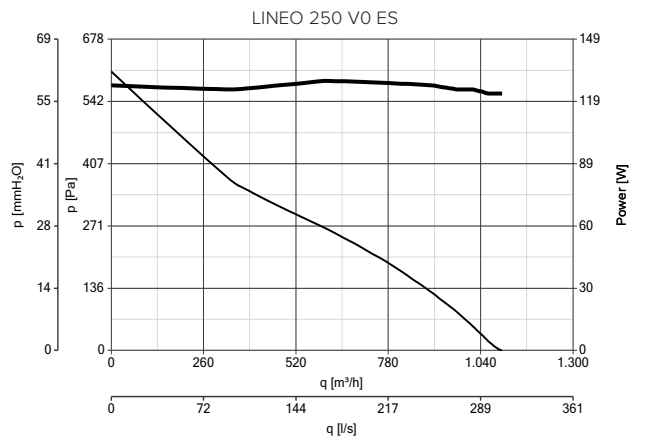
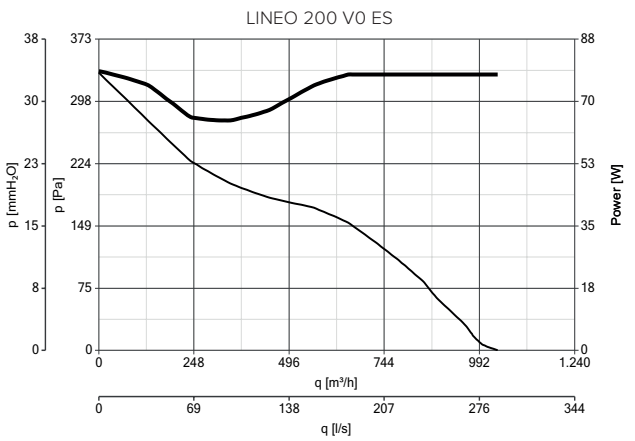
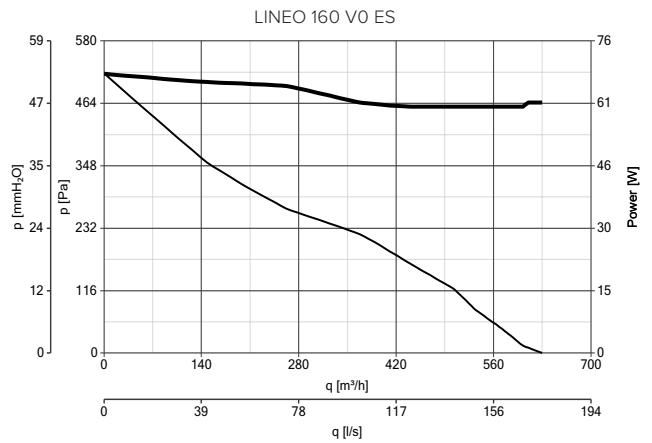
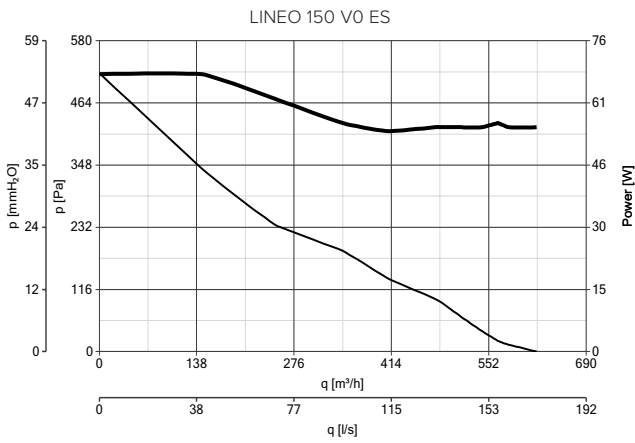
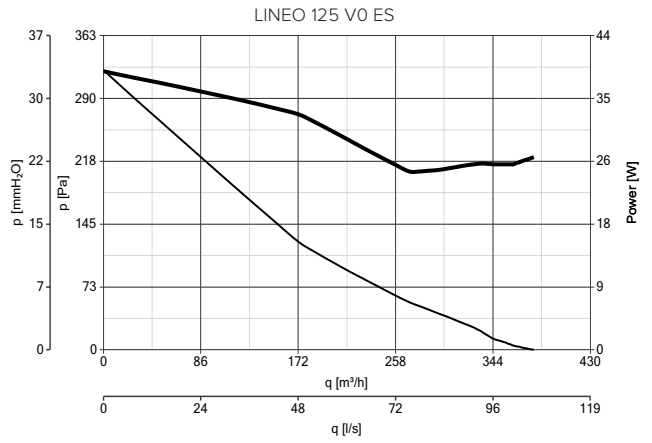
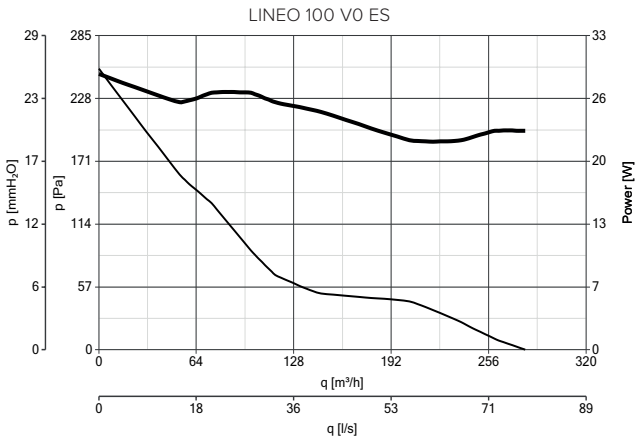

— max  
— min



PERFORMANCES CURVES

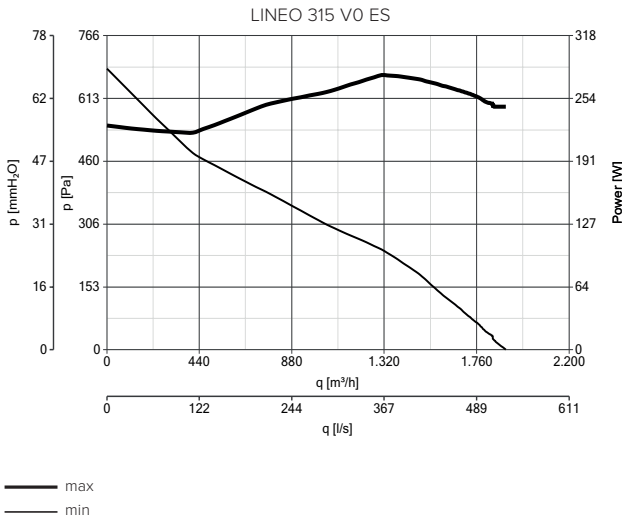









## COMMERCIAL VENTILATION

LINEO V0 ES RANGE

### CONTROLLERS

MODELS	DESCRIPTION	CODE	PRODUCT
	<b>DUO</b> - 2 SPEEDS CONTROLLER	22914	ALL PRODUCTS
	<b>POT</b> - POTENTIOMETER	12828	ALL PRODUCTS
	<b>POT-IT</b> - POTENTIOMETER	12826	ALL PRODUCTS
	<b>C TEMP</b> - THERMO SWITCH	12992	ALL PRODUCTS
	<b>C SMOKE</b> - AIR QUALITY SENSOR	12993	ALL PRODUCTS
	<b>C HCS</b> - HUMIDISTAT	12994	ALL PRODUCTS
	<b>C PIR</b> - PASSIVE INFRARED SENSOR	12998	ALL PRODUCTS
	<b>C TIMER</b> - TIMER	12999	ALL PRODUCTS

### ACCESSORIES ON REQUEST

MODELS	DESCRIPTION	CODE	PRODUCT	
		100	22701	17150
		125	22702	17152
		150	22703	17153
	<b>LINEO-G</b> - PROTECTION GRILLE	160	22704	17154
		200	22705	17155
		250	22706	17156
		315	22707	17157







## CA V0 RANGE

In-line centrifugal fans in self-extinguishing plastic



Self-extinguishing plastic resin mixed flow duct fans, installed in false ceilings or in attics. The ideal low-visual impact ventilation solution for residential, commercial or industrial premises (kitchens, toilets, laboratories, bars, restaurants, laundries, shops, etc.).

### VERSIONS

7 models, with nominal diameter between 100 and 315 mm.

### KEY FEATURES

- Built to withstand aggressive agents.
- Standard supplied support brackets.
- High protection rating from dust and water for safe use in industrial environments.
- Wide continuous operation temperature range (-25 °C / + 50 °C).
- Can be installed horizontally, vertically or sloping.
- Fully compliant with Reg. ErP 2018 N. 1253/2014

### TECHNICAL FEATURES

- Casing built into the boxes containing the mains connection terminals and the flow conditioner fins, constructed in self-extinguishing plastic resin (V0).
- 3-speed fans that can be set using optional device TRIO-CA (code 12869), composed of:
  - AC motors with thermal overload cut-out and shafts turning on ball bearings to guarantee long lasting continuous service (at least 30,000 h) at the maximum plate temperature.
  - Backward-curve, heat resistant plastic resin blade impellers loaded with glass fibre to combine structural strength and dimensional stability.
  - Galvanised steel sheet brackets for wall, ceiling and false ceiling installation.
- Possibility of connecting to remote environmental temperature, humidity, smoke and presence sensors (optional).
- Protection rating from dusts and water: IP44 (appliance ducted in extraction and delivery).
- Insulation Class: II .

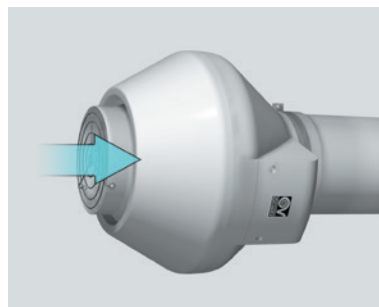
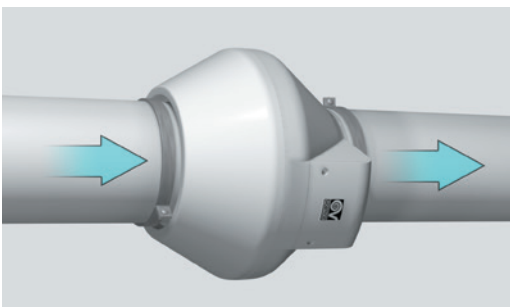



TECHNICAL DATA

Models	Code	V~50/60HZ	W		A		RPM		Max Airflow		Max Pressure		LP DB(A) 3m	Max °C	KG
			min/med/max	min/med/max	min/med/max	min/med/max	m³/h	l/s	mmH <sub>2</sub> O	Pa					
CA100 V0 D	16008	220-240	14	0.14	1660	85	24	27	269	51	50	2.4			
			27	0.19	-	156	43	36	360	-					
			50	0.22	2400	251	69.7	37	366	56*					
CA125 V0 D	16018	220-240	14	0.14	1480	107	29	19	195	45	50	2.3			
			27	0.19	-	200	55	33	333	-					
			52	0.22	2400	300	83	34.7	340	56*					
CA150 V0 D	16028	220-240	14	0.14	1400	150	41	8.4	83	44	50	2.6			
			27	0.19	-	275	76	24	241	-					
			52	0.22	2400	460	128	31.8	312	56*					
CA200 V0 Q	16035	220-240	35	0.35	-	310	87	22	215	-	50	3.1			
			48	0.40	-	415	115	35	351	-					
			104	0.45	2355	805	224	44.7	438	59*					
CA200 V0 E	16038	220-240	39	0.35	1320	387.1	107.5	24.6	241.2	-	50	3.5			
			58	0.40	2015	605	215.3	39.2	392	-					
			90	0.40	2611	775	215.3	42.2	413.9	50.3**					
CA250 V0 E	16039	220-240	45	0.37	1600	525	145.8	22.2	218	-	50	3.7			
			62	0.39	2190	730	202	35	344	-					
			90	0.40	2610	855	237.5	38.1	373.3	49.9**					
CA315 V0 E	16041	220-240	48	0.48	1280	527	146.3	27.5	270	-	55	5.5			
			80	0.57	1970	825	229	50	488	-					
			120	0.54	2640	1100	305.5	56.6	554.7	54**					

\* Sound pressure level measured at 3 m in free field conditions with long-cased appliance in delivery mode in accordance with standard EN ISO 3741.

\*\* Sound pressure level measured at 3 m in free field conditions with long-cased appliance in delivery mode in accordance with standard EN ISO 9614.

## CA V0 RANGE

Available only for Extra EU market and therefore not in compliance with Reg. ErP 2018

- 4 models, with nominal diameter between 100 and 200 mm.
- 1 or 2-speed (depending on the model) motors with thermal overload cut-out and shafts turning on ball bearings to guarantee long lasting continuous service (at least 30,000 h) at the maximum plate temperature. Speed adjustment using Vortice accessory devices.
- Performance and safety certified by third party body (IMQ).

TECHNICAL DATA - AVAILABLE ONLY FOR EXTRA EU MARKET

Models	Code	V~50/60HZ	W		A		RPM		Max Airflow		Max Pressure		LP DB(A) 3m	Max °C	KG
			min/max	min/max	min/max	min/max	m³/h	l/s	mmH <sub>2</sub> O	Pa					
CA100 V0 D*	16034	220-240	65 85	0,32 0,38	1660 2540	150 235	41,7 65,3	30 40	274 392	51 56**	50	2,4			
CA125 V0 D*	16044	220-240	67 85	0,34 0,40	1480 2470	210 360	58,3 100	25 36	245 353	45 56**	50	2,3			
CA150 V0 D*	16054	220-240	70 85	0,34 0,41	1400 2390	280 500	77,8 138,9	20 34	196 333	44 56**	50	2,6			
CA200 V0 Q*	16064	220-240	100	0,35	2290	700	194,4	37	363	59**	50	4,1			

\* Available only for Extra EU markets

\*\* Sound pressure level measured at 3 m in free field conditions with long-cased appliance in delivery mode in accordance with standard EN ISO 3741.

\*\*\* Sound pressure level measured at 3 m in free field conditions with long-cased appliance in delivery mode in accordance with standard EN ISO 9614.

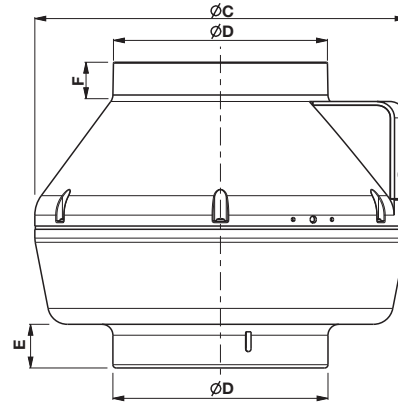
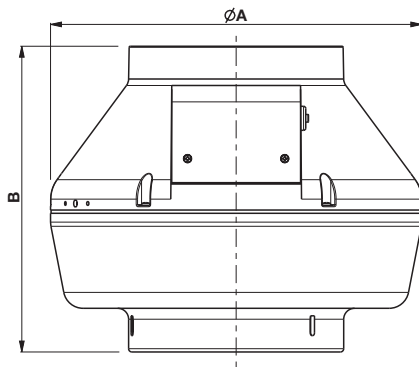
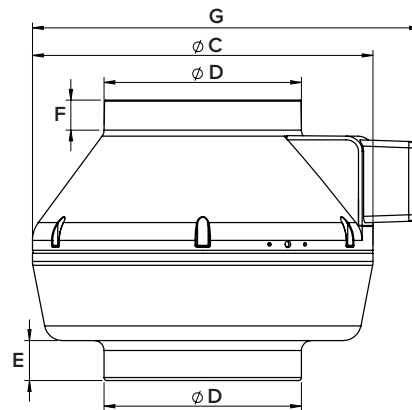
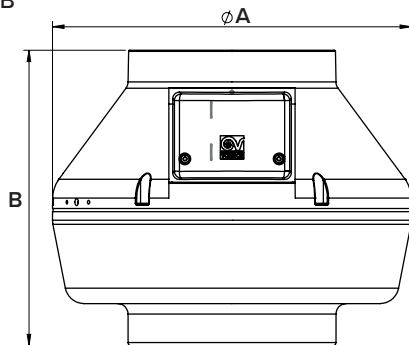
**DIMENSIONS**
**TYPE A**

**TYPE B**

MODELS	ØA	B	ØC	ØD	E	F	G
CA 100 V0 D (TYPE A)	250	250	250	97	30	30	-
CA 125 V0 D (TYPE A)	250	250	250	122	30	30	-
CA 150 V0 D (TYPE A)	300	305	300	147/157	30/30	30/60	-
CA 200 V0 Q (TYPE B)	340	280	340	197	40	30	390
CA 200 V0 E (TYPE B)	340	280	340	197	40	30	390
CA 250 V0 E (TYPE B)	340	305	340	247	60	30	390
CA 315 V0 E (TYPE B)	400	340	400	312	75	40	438

Dimensions (mm)

**AVAILABLE ONLY FOR EXTRA EU MARKET**

MODELS	ØA	B	ØC	ØD	E	F
CA 100 V0 D (TYPE A)	250	250	250	97	30	30
CA 125 V0 D (TYPE A)	250	250	250	122	30	30
CA 150 V0 D (TYPE A)	300	305	300	147/157	30/60	30/60
CA 200 V0 Q (TYPE A)	340	280	340	197	40	30

Dimensions (mm)



PERFORMANCES CURVES

CA 100 V0 D

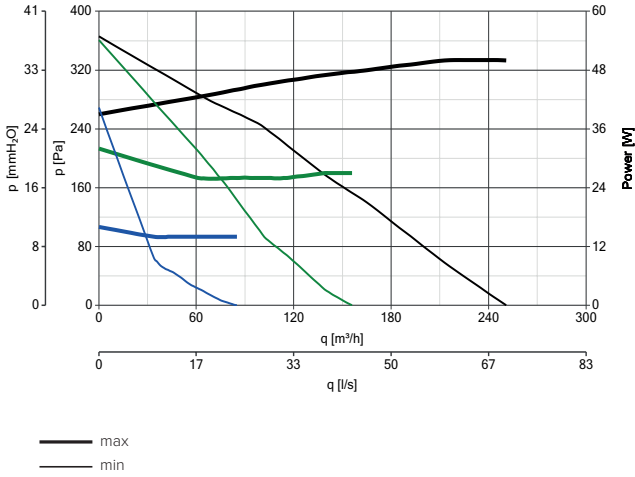

CA 125 V0 D

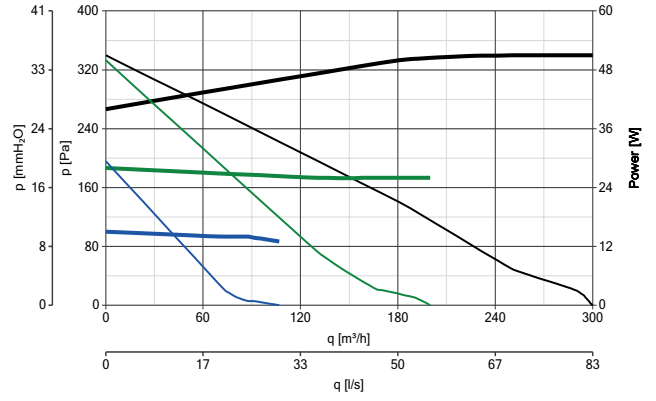

CA 150 V0 D

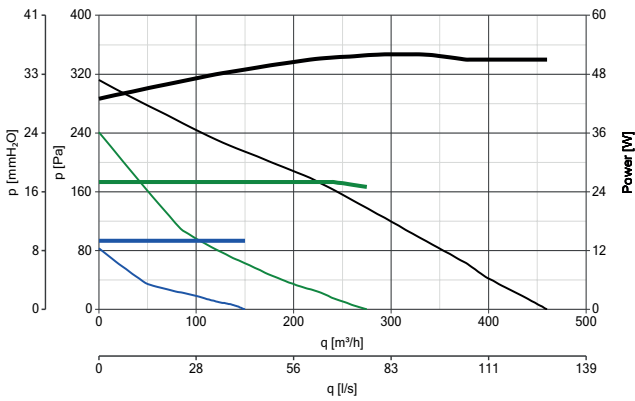

CA 200 V0 Q

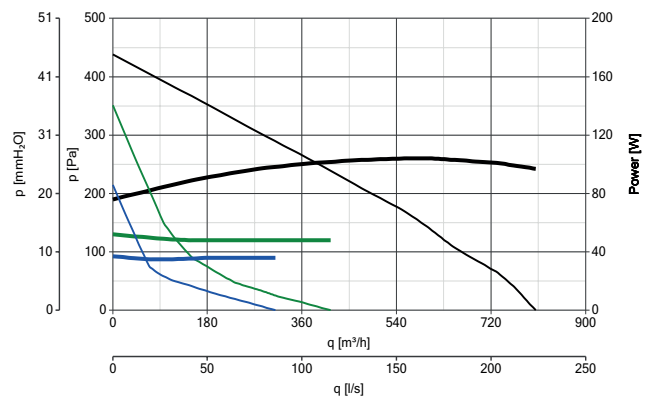

CA 200 V0 E

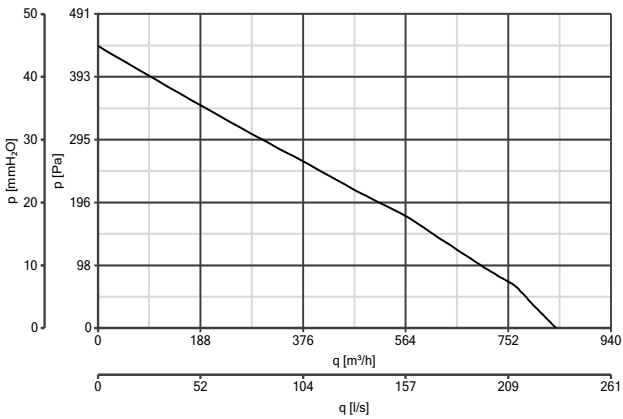

CA 250 V0 E

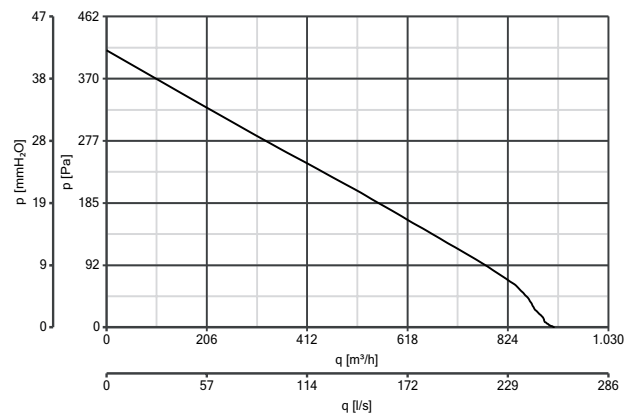



# COMMERCIAL VENTILATION

CA V0 RANGE

## PERFORMANCES CURVES

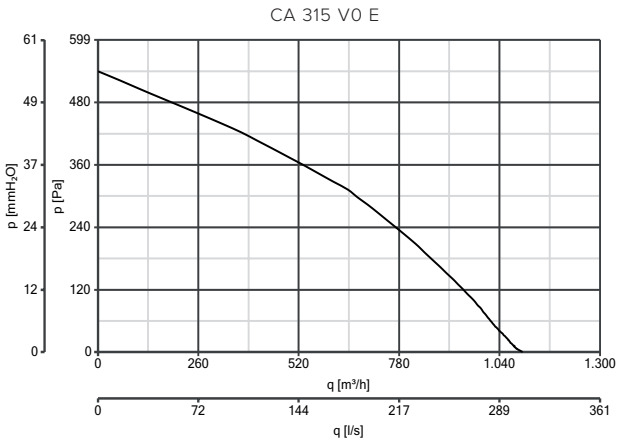

## AVAILABLE ONLY FOR EXTRA EU MARKET

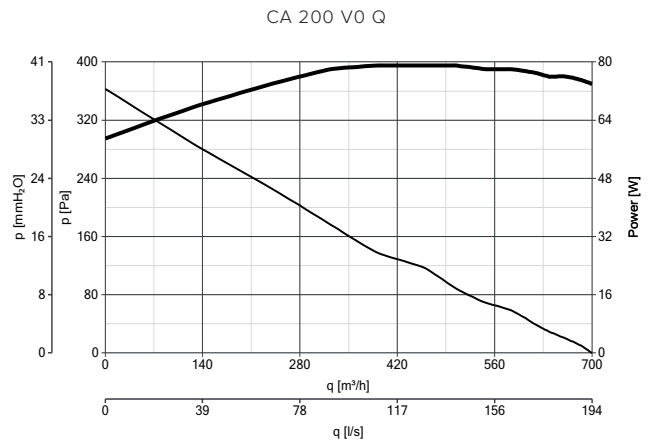
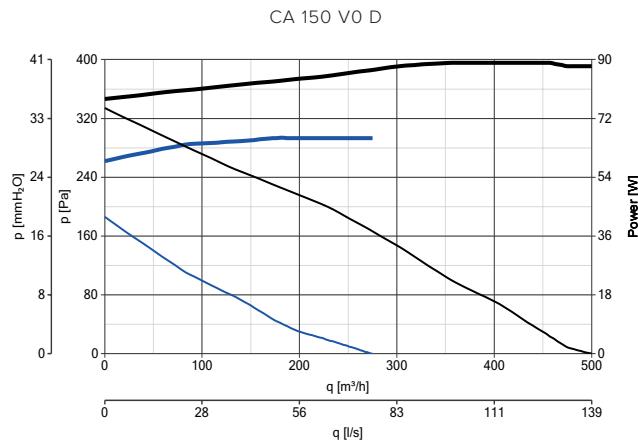
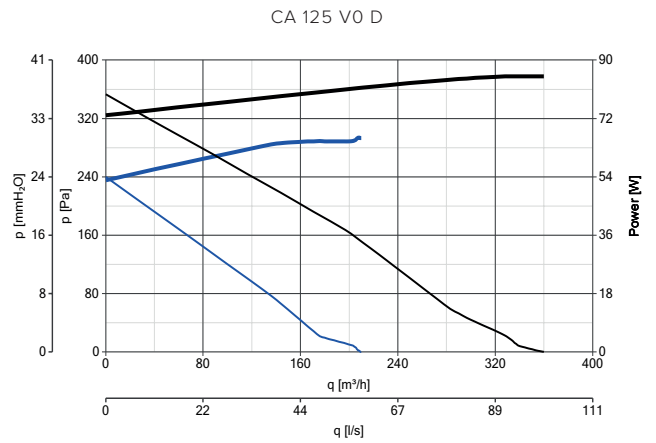
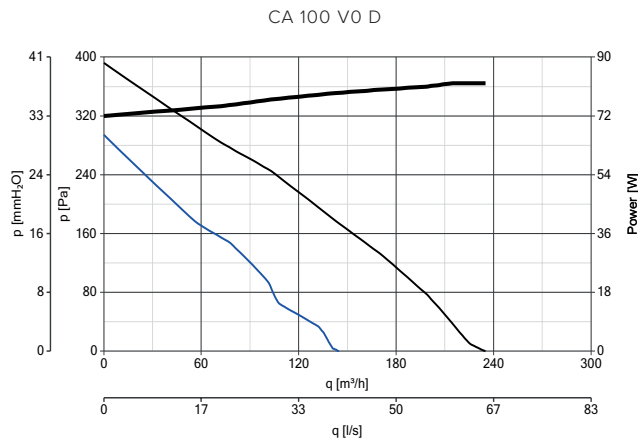









POWER CONSUMPTION PERFORMANCES CURVES  
 — max — min  
 — max — min







**CONTROLLERS**

MODELS	DESCRIPTION	CODE	PRODUCT
	<b>C 1.5</b> - ELECTRONIC SPEED CONTROLLER 1.5 A	12966	ALL PRODUCTS
	<b>C 2.5</b> - ELECTRONIC SPEED CONTROLLER 2.5 A	12967	ALL PRODUCTS
	<b>SCNRB</b> - BUILT-IN ELECTRONIC SPEED CONTROLLER	12971	ALL PRODUCTS
	<b>TRIO</b> - 3 SPEED SWITCH FOR WALL AND FLUSH MOUNTING INSIDE UNI 503 STANDARD ELECTRIC BOXES	12869	16008 - 16018 - 16028 - 16035 - 16038 - 16039 - 16041
	<b>KIT SCB</b> - BUILT-IN CONTROLLER ADAPTOR	22481	12966 - 12967
	<b>IREM D</b> - ELECTRONIC SPEED CONTROLLER FOR INSTALLATION IN STANDARD DIN BOX. MAXIMUM LOAD: 1.0 A.	12867	ALL PRODUCTS
	<b>DUO</b> - 2 SPEEDS CONTROLLER	22914	16034 - 16044 - 16054 - 16064
	<b>C TEMP</b> - THERMO SWITCH	12992	ALL PRODUCTS
	<b>C SMOKE</b> - AIR QUALITY SENSOR	12993	ALL PRODUCTS
	<b>C HCS</b> - HUMIDISTAT	12994	ALL PRODUCTS
	<b>C PIR</b> - PASSIVE INFRARED SENSOR	12998	ALL PRODUCTS
	<b>C TIMER</b> - TIMER	12999	ALL PRODUCTS

**ACCESSORIES ON REQUEST**

MODELS	DESCRIPTION	CODE	PRODUCT
	<b>CA-MU</b> - MOUNTING BRACKETS	22674	ALL PRODUCTS
		100	22750
		125	22755
		150	22760
	<b>CA-G</b> - PROTECTION GRILLE	200	22765
		250	22770
		315	22775
			16008
			16018
			16028
			16035 - 16038
			16039
			16041

## CA MD RANGE

In-line centrifugal fans in metal

Painted sheet steel mixed flow duct fans, installed in false ceilings or in attics. The ideal low-visual impact ventilation solution for residential, commercial or industrial premises (kitchens, toilets, laboratories, bars, restaurants, laundries, shops, etc).

### VERSIONS

8 models, with nominal diameter between 100 and 315 mm.

### KEY FEATURES

- Built to withstand weathering and high temperatures.
- Standard supplied support brackets.
- High protection rating from dust and water for safe use in industrial environments.
- Wide continuous operation temperature range (-25 °C / + 50 °C).
- Can be installed horizontally, vertically or sloping.

### TECHNICAL FEATURES

- Pickled, phosphate-coated steel sheet casing that has been painted with polyester paint against aggressive weathering.
- Motor-holder built into the boxes housing the mains connection terminals and the flow conditioner fins, constructed in self-extinguishing plastic resin (V0).
- 3-speed fans that can be set using optional device TRIO-CA (code 12869), composed of:
  - AC motors with thermal overload cut-out and shafts turning on ball bearings to guarantee long lasting continuous service (at least 30,000 h) at the maximum plate temperature.
  - Backward-curve, heat resistant plastic resin blade impellers loaded with glass fibre to combine structural strength and dimensional stability.
- Galvanised steel sheet brackets for wall, ceiling and false ceiling installation.
- Possibility of connecting to remote environmental temperature, humidity, smoke and presence sensors (optional).
- Performance and safety certified by third party body (IMQ).
- Protection rating from dusts and water: IP44 (appliance ducted in extraction and delivery).
- Insulation Class: II .

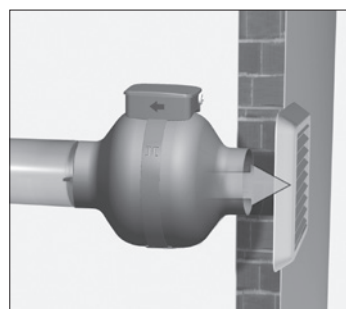



TECHNICAL DATA

Models	Code	V~50HZ	W min/med/max	A min/med/max	RPM min/med/max	Max Airflow		Max Pressure		LP DB(A) 3m min/med/max	Max °C	KG
						m³/h min/med/max	l/s min/med/max	mmH <sub>2</sub> O min/med/max	Pa min/med/max			
CA 100 MD	16150	230	26	0,22	1190	163	45,0	19,9	195,9	32,3*	50	2,97
			47	0,30	1810	250	69,4	33	323,4	-		
			85	0,40	2370	337	93,0	38,9	381,6	43,2*		
CA 125 MD	16151	230	26	0,22	1130	210	58,0	17,6	172,6	30,8*	50	3,0
			47	0,30	1685	315	87,5	30,7	301,3	-		
			85	0,40	2300	445	123,6	36,8	361,4	45,9*		
CA 150 MD E	16163	230	26	0,22	1160	230	63,8	12,3	121,0	42,3**	50	4,9
			47	0,30	1725	350	97,2	25,3	248,7	-		
			85	0,38	2650	535	148,6	44,3	435,1	53,2**		
CA 150 Q MD	16152	230	26	0,22	1160	230	63,8	12,3	121,1	34,7*	50	2,98
			47	0,30	1725	350	97,2	25,3	248,2	-		
			85	0,40	2340	470	130,5	33,3	327,0	48,1*		
CA 160 MD E	16164	230	39	0,35	1130	325	90,2	32,7	321,5	43,4*	50	4,9
			53	0,36	2160	450	125	41,8	409,8	-		
			85	0,38	2665	555	154,1	44,0	431,8	53,4*		
CA 200 MD E	16165	230	39	0,35	1440	412	114,0	36,0	353,0	36,2**	50	4,8
			57	0,38	2140	620	172,2	45,0	441,0	-		
			89	0,43	2630	775	215,0	45,0	441,0	48,1**		
CA 250 MD E	16166	230	50	0,47	1410	540	150,0	33,7	330,8	38,3**	50	5,3
			82	0,55	2120	805	223,6	49,2	482,6	-		
			120	0,53	2635	1010	280,5	54,8	537,6	52,7**		
CA 315 MD E	16167	230	50	0,47	1510	570	158,3	36,0	353,2	41,8**	50	7,0
			82	0,54	2150	830	230,5	50,7	497,3	-		
			120	0,53	2630	1015	281,9	55,5	544,9	52,3**		

\* Sound pressure level measured at 3 m in free field conditions with long-cased appliance in delivery mode in accordance with standard EN ISO 3741.

\*\* Sound pressure level measured at 3 m in free field conditions with long-cased appliance in delivery mode in accordance with standard EN ISO 9614.

## CA MD RANGE

Available only for Extra EU market and therefore not in compliance with Reg. ErP 2018

- 8 models, with nominal diameter between 100 and 315 mm.
- 2-speed motors with thermal overload cut-out and shaft turning in ball bearings to guarantee long lasting continuous service (at least 30,000 h) at the maximum plate temperature. Speed adjustment using Vortice accessory devices.
- Performance and safety certified by third party body (IMQ).

TECHNICAL DATA - AVAILABLE ONLY FOR EXTRA EU MARKET

Models	Code	V~50/60HZ	W min/max	A min/max	RPM min/max	Max Airflow		Max Pressure		LP DB(A) 3m min/max	Max °C	KG
						m³/h min/max	l/s min/max	mmH <sub>2</sub> O min/max	Pa min/max			
CA 100 MD*	16107	220-240	60	0.30	1730	220	61	30	294	32.2**	50	2.97
			85	0.40	2450	340	94	39	383	43.2**		
CA 125 MD*	16108	220-240	60	0.30	1580	280	78	27	265	30.8**	50	3.0
			85	0.40	2380	450	125	37	363	45.9**		
CA 150 MD*	16153	220-240	110 155	0.50 0.70	1815 2080	570 770	188 214	44 54	432 530	40.7 48.0	50	5.52
CA 150 Q MD*	16109	220-240	60 85	0.30 0.40	1430 2350	300 500	83 139	21 35	206 343	34.7** 48.1**	50	2.98
CA 160 M*	16154	220-240	110 155	0.55 0.70	1654 2080	640 840	178 228	41 50	402 491	40.7 47.4	50	5.47
CA 200 MD*	16155	220-240	110 155	0.55 0.70	1700 2100	820 1050	228 292	37 48	363 471	43.8 49.6	50	5.43
CA 250 MD*	16156	220-240	115 200	0.55 0.90	1800 2420	950 1300	264 361	42 56	412 549	46.7 55.9	50	6.55
CA 315 MD*	16157	220-240	190 280	0.85 1.25	1940 2500	1350 1800	375 500	52 72	510 706	52.4 57.7	50	9.47

\* Available only for the Extra EU market

\*\* Sound pressure level measured at 3 m in free field conditions with long-cased appliance in delivery mode in accordance with standard EN ISO 3741.

\*\*\* Sound pressure level measured at 3 m in free field conditions with long-cased appliance in delivery mode in accordance with standard EN ISO 9614.



## COMMERCIAL VENTILATION

### CA MD RANGE

#### ENERGY DATA FOR REGULATION N° 1254/2014/UE

	UNIT OF MEASURE	CA 160 MD E	CA 200 MD E	CA 250 MD E	CA 315 MD E
<b>CODE</b>		16164	16165	16166	16167
Supplier's name or trade mark	-	Vortice	Vortice	Vortice	Vortice
SFPint	W(m³/s)	482,85	382,78	397,50	385,03
Declared typology	-	NRVU-U**	NRVU-U**	NRVU-U**	NRVU-U**
Type of drive	-	MSD***	MSD***	MSD***	MSD***
Type of heat recovery system HRS	-	None	None	None	None
Nominal NRVU flow rate	m³/s	0,13611	0,21389	0,2747	0,2791
Effective electric power input	kW	0,088	0,089	0,127	0,123
Face velocity at design flow rate	m/s	6,7696	6,8083	5,5966	3,5822
Nominal external pressure ( $\Delta p_s$ , ext)	Pa	70	12	21	18
Internal pressure drop of ventilation components ( $\Delta p_s$ ,int)	Pa	279	135	126	122
Internal pressure drop of non-ventilation components ( $\Delta p_s$ ,add)	Pa	0	0	0	0
Static efficiency of fans used in accordance with Regulation (EU) N. 327/2011	%	43,2	35,3	31,8	31,8
Declared maximum internal leakage rate of the casing of ventilation units	%	NA*	NA*	NA*	NA*
Declared maximum external leakage rate of the casing of ventilation units	%	5,9	4,2	2,3	2,2
Energy performance energy or classification of the filters	-	NA*	NA*	NA*	NA*
Description of visual filter warning	-	NA*	NA*	NA*	NA*
Casing sound power level	LWA[dB(A)]	74	69	73	73

	UNIT OF MEASURE	CA 100 MD	CA 125 MD	CA 150 MD E	CA 150 Q MD
<b>CODE</b>		16150	16151	16163	16152
Supplier's name or trade mark	-	Vortice	Vortice	Vortice	Vortice
SFPint	W(m³/s)	602,29	478,53	567,30	408,13
Declared typology	-	NRVU-U**	NRVU-U**	NRVU-U**	NRVU-U**
Type of drive	-	MSD***	MSD***	MSD***	MSD***
Type of heat recovery system HRS	-	None	None	None	None
Nominal NRVU flow rate	m³/s	0,07917	0,09861	0,14333	0,10260
Effective electric power input	kW	0,051	0,051	0,086	0,053
Face velocity at design flow rate	m/s	10,08	8,0335	8,1110	5,8003
Nominal external pressure ( $\Delta p_s$ , ext)	Pa	12,8	8,8	15	31,4
Internal pressure drop of ventilation components ( $\Delta p_s$ ,int)	Pa	183	148	255	149
Internal pressure drop of non-ventilation components ( $\Delta p_s$ ,add)	Pa	0	0	0	0
Static efficiency of fans used in accordance with Regulation (EU) N. 327/2011	%	30,4	30,7	44,9	28,8
Declared maximum internal leakage rate of the casing of ventilation units	%	NA*	NA*	NA*	NA*
Declared maximum external leakage rate of the casing of ventilation units	%	3,6	3,0	6,3	2,8
Energy performance energy or classification of the filters	-	NA*	NA*	NA*	NA*
Description of visual filter warning	-	NA*	NA*	NA*	NA*
Casing sound power level	LWA[dB(A)]	64	66	74	69

\*NA: Not applicable - \*\*RVU-U: Non Residential Ventilation Unit - Unidirectional - \*\*\*MSD: Multi-Speed Drive



DIMENSIONS

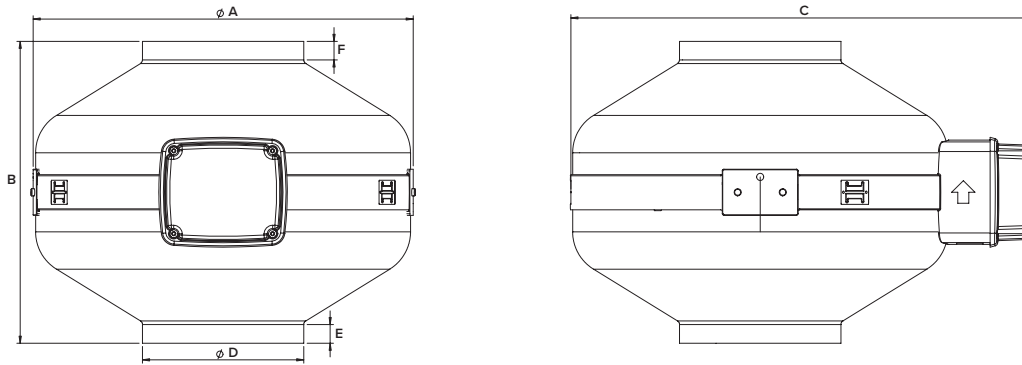

MODELS	ØA	B	C	ØD	E	F
CA 100	255	239	330	97	15	15
CA 125	255	239	330	122	23	23
CA 150 Q	255	239	330	147	30	30
CA 150	347	275	424	147	17	17
CA 160	347	275	424	157	18	18
CA 200	347	275	424	197	20	17
CA 250	347	275	424	247	38	35
CA 315	406	306	488	312	21	30

Dimensions (mm)

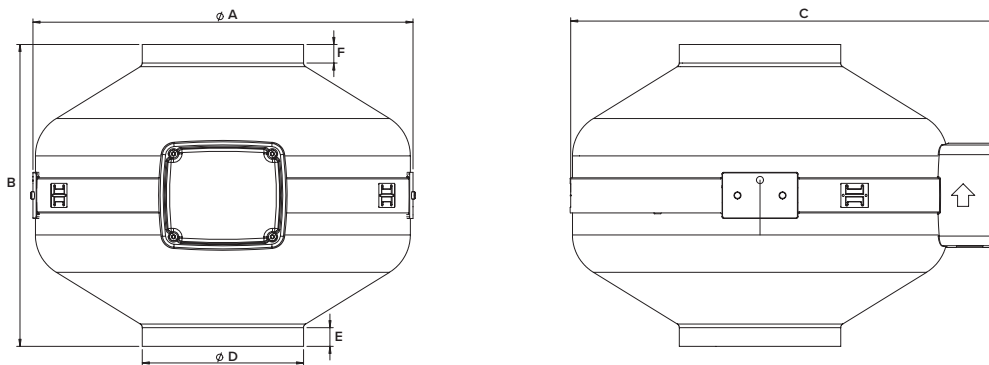

AVAILABLE ONLY FOR EXTRA EU MARKET

MODELS	ØA	B	C	ØD	E	F
CA 100	255	239	300	97	15	15
CA 125	255	239	300	122	23	23
CA 150 Q	255	239	300	147	30	30
CA 150	347	275	424	147	17	17
CA 160	347	375	424	157	18	18
CA 200	347	275	424	197	20	17
CA 250	347	375	394	247	38	35
CA 315	406	306	458	312	21	30

Dimensions (mm)





# COMMERCIAL VENTILATION

CA MD RANGE

## PERFORMANCES CURVES

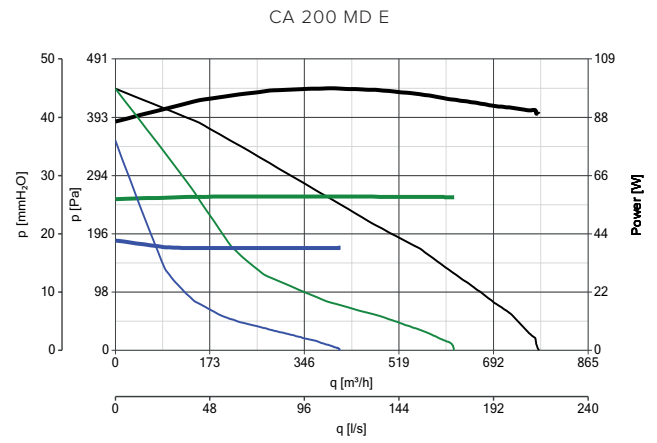
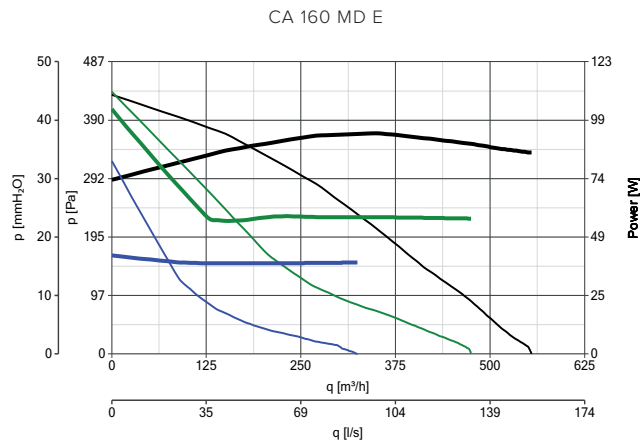
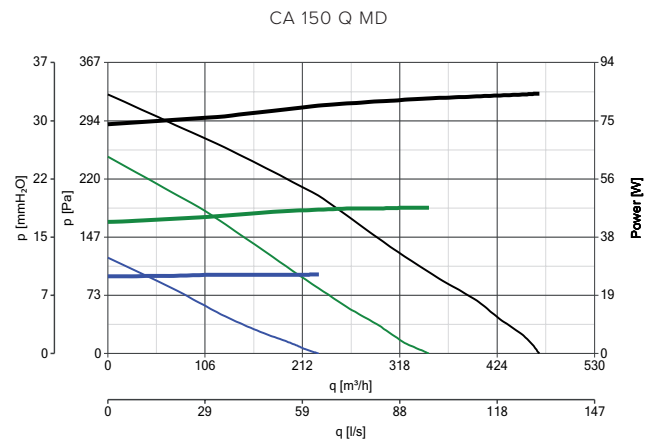
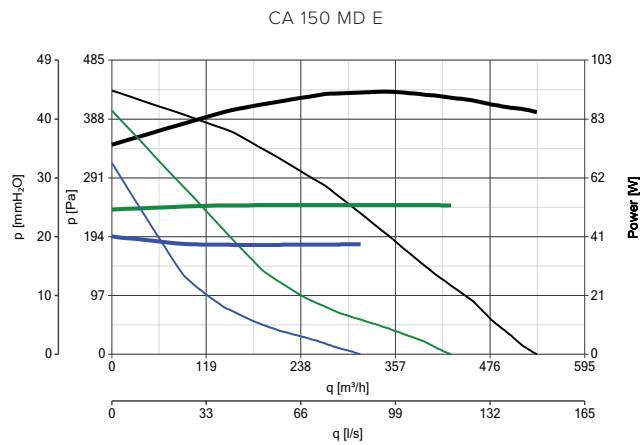
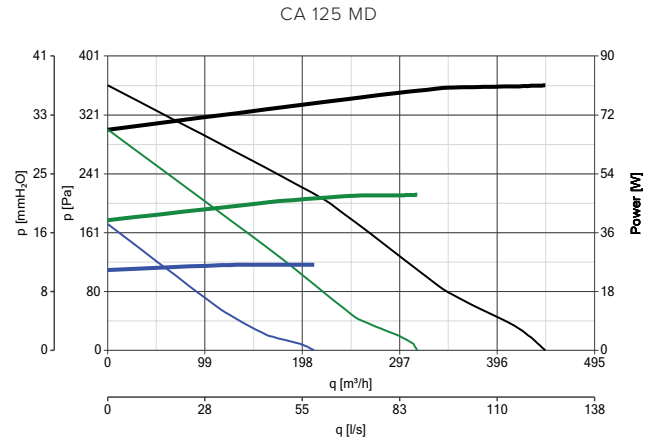
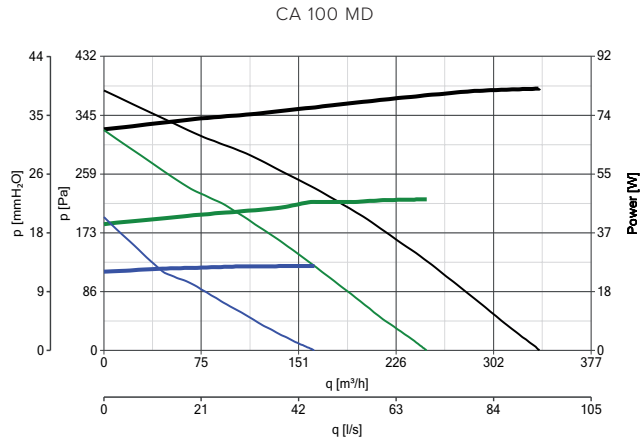

POWER CONSUMPTION  
 — max  
 — med  
 — min

PERFORMANCE CURVES  
 — max  
 — med  
 — min



PERFORMANCES CURVES

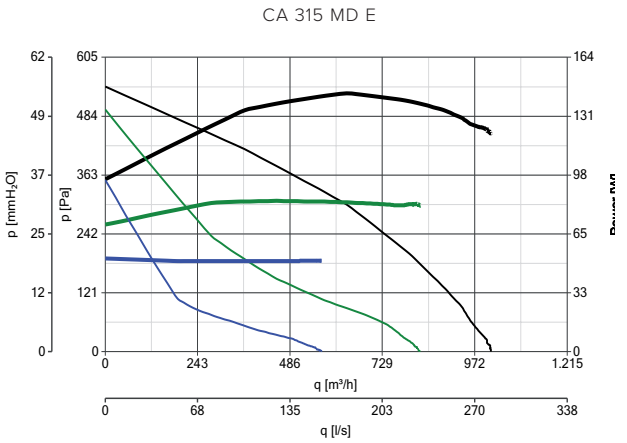
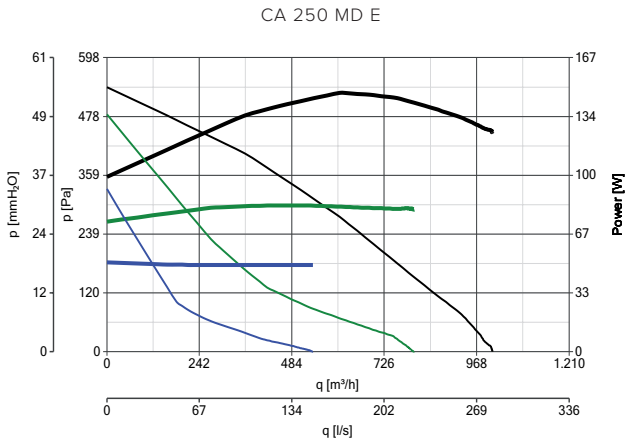

POWER CONSUMPTION  
— max  
— med  
— min

PERFORMANCE CURVES  
— max  
— med  
— min





# COMMERCIAL VENTILATION

CA MD RANGE

AVAILABLE ONLY FOR EXTRA EU MARKET

CA 100 MD\*

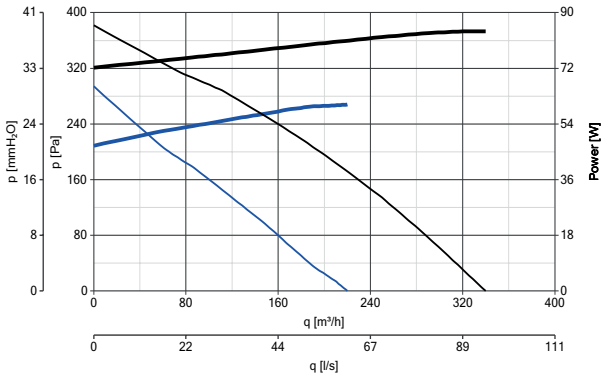

CA 125 MD\*

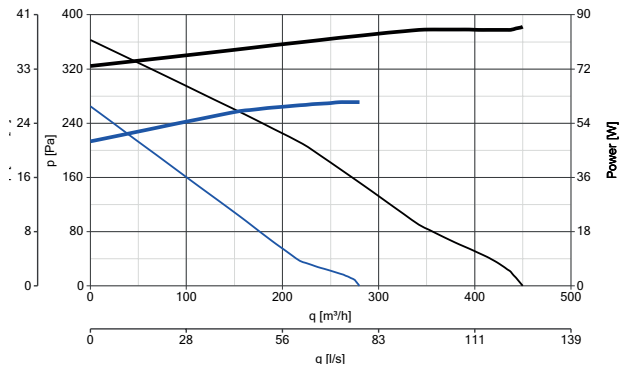

CA 150 MD\*

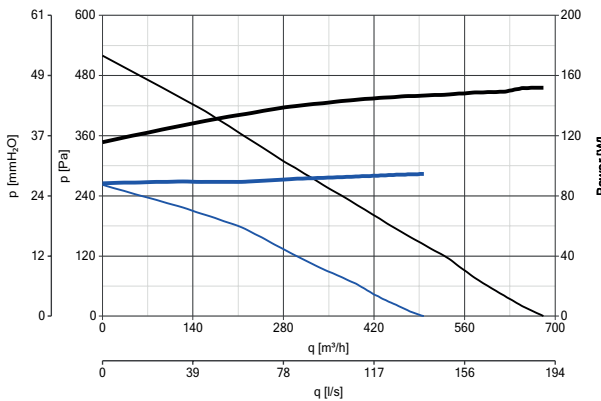

CA 150 Q MD\*

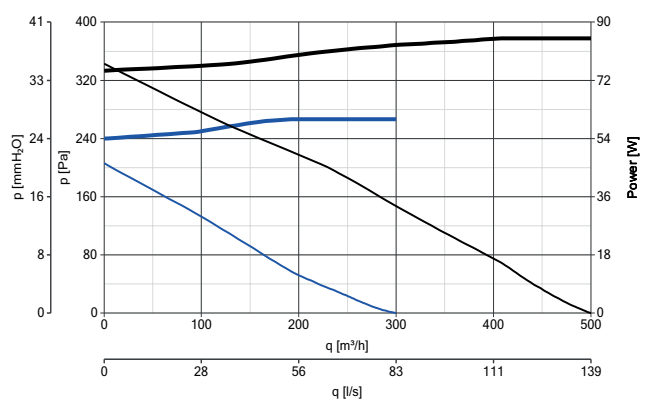

\* Available only for Extra EU markets

CA 160 MD

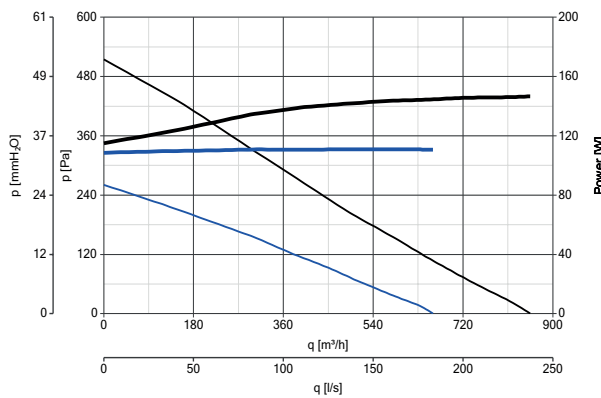

CA 200 MD

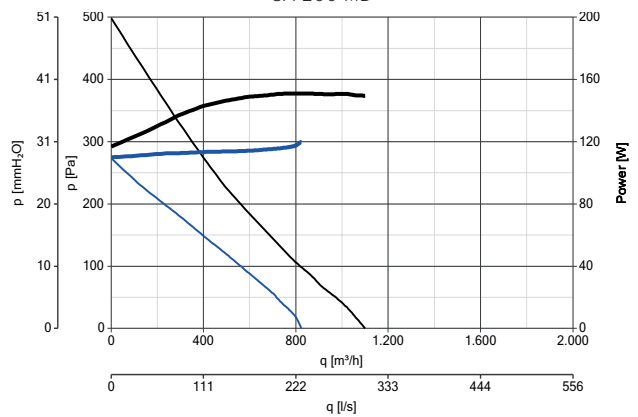

PERFORMANCES CURVES

- max
- min





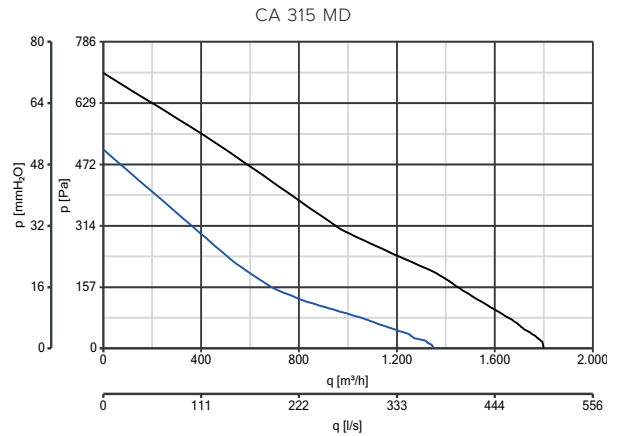
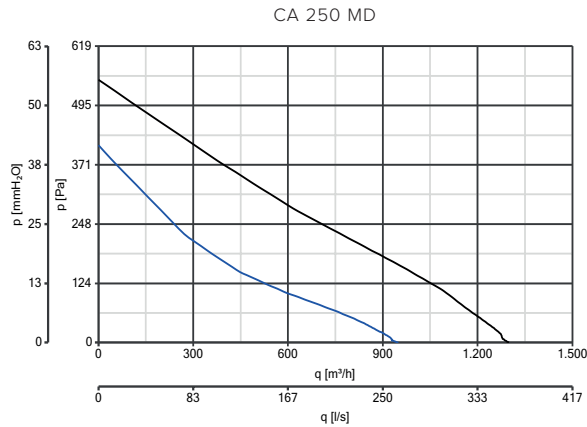

AVAILABLE ONLY FOR EXTRA EU MARKET





PERFORMANCES CURVES

— max  
— min

CONTROLLERS

MODELS	DESCRIPTION	CODE	PRODUCT
	<b>C 1.5</b> - ELECTRONIC SPEED CONTROLLER 1.5 A	12966	ALL PRODUCTS
	<b>C 2.5</b> - ELECTRONIC SPEED CONTROLLER 2.5 A	12967	ALL PRODUCTS
	<b>SCNRB</b> - ELECTRONIC SPEED CONTROLLER. BUILT-IN	12971	ALL PRODUCTS
	<b>KIT SCB</b> - BUILT-IN CONTROLLER ADAPTOR	22481	12966 - 12967
	<b>TRIO</b> - 3 SPEED SWITCH FOR WALL AND FLUSH MOUNTING INSIDE UNI 503 STANDARD ELECTRIC BOXES	12869	16150 - 16151 - 16163 - 16152 - 16164 16165 - 16166 - 16167

ACCESSORIES ON REQUEST

MODELS	DESCRIPTION	CODE	PRODUCT
	<b>CA-MU</b> - MOUNTING BRACKETS	22674	ALL PRODUCTS
		100	22750
		125	22755
		150	22760
		200	22765
		250	22770
		315	22775
	<b>CA-G</b> - PROTECTION GRILLE		16150 - 16107 16151 - 16108 16152 - 16163 - 16109 - 16153 16165 - 16155 16166 - 16156 16167 - 16157

## CA ES RANGE

"Energy Saving" in-line centrifugal fans in metal

Painted sheet steel mixed flow duct fans equipped with 2-speed brushless motors. Installed in false ceilings or attics, ensuring the proper ventilation of residential, commercial or industrial premises (kitchens, toilets, laboratories, bars, restaurants, laundries, shops, etc.), combining their low-visual impact with especially low consumption.

### VERSIONS

8 models, with nominal diameter between 100 and 315 mm.

### KEY FEATURES

- High efficiency EC (brushless) motors that are continuously adjustable (0-10V signal) or are settable at installation for 2-speed operation that can be set as needed.
- Built to withstand weathering and high temperatures.
- Standard supplied support brackets.
- High protection rating from dust and water for safe use in industrial environments.
- Wide continuous operation temperature range (-25 °C / + 50 °C).
- Can be installed horizontally, vertically or sloping.

### TECHNICAL FEATURES

- Pickled, phosphate-coated steel sheet casing that has been painted with polyester paint against aggressive weathering.
- Motor-holder built into the boxes containing motor drivers and the flow conditioner fins, constructed in self-extinguishing plastic resin (V0).
- Two-speed EC (brushless) motors with thermal overload cut-out and shafts turning on ball bearings to guarantee long lasting (at least 40,000 h) continuous service at the maximum plate temperature. Possibility of continuous speed adjustment through potentiometers (0-10V signal).
- Backward-curve, heat resistant plastic resin blade impellers loaded with glass fibre to combine structural strength and dimensional stability.
- Galvanised steel sheet brackets for wall, ceiling and false ceiling installation.
- Possibility of connecting to remote environmental temperature, humidity, smoke and presence sensors (optional).
- Protection rating from dusts and water: IP44 (appliance ducted in extraction and delivery).
- Insulation Class: II .

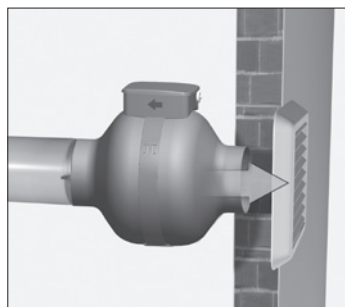





TECHNICAL DATA

Models	Code	V-50	W min/max	A min/max	RPM min/max	Max Airflow		Max Pressure		LP DB(A) 3m* max	Max °C	KG
						m³/h min/max	l/s min/max	mmH <sub>2</sub> O min/max	Pa min/max			
CA 100 ES	16200	220-240	3 80	0,05 0,7	300 2720	33 385	9 107	0,5 52	5 510	46,9	50	2,7
CA 125 ES	16201	220-240	3 80	0,05 0,7	300 2650	52 520	14 144	0,5 47	5 461	49,7	50	2,6
CA 150 ES	16203	220-240	3 120	0,05 1,0	300 2250	100 800	28 222	0,7 100	7 490	48,1	50	4,5
CA 150 Q ES	16202	220-240	3 80	0,05 0,7	300 2670	56 560	16 156	5 45	5 441	49,6	50	2,6
CA 160 ES	16204	220-240	3 120	0,05 1	300 2240	110 900	31 250	0,7 50	7 490	48,1	50	4,6
CA 200 ES	16205	220-240	3 120	0,05 1	300 2280	125 1140	35 317	0,7 50	7 490	47,6	50	4,6
CA 250 ES	16206	220-240	4,5 140	0,05 1,1	300 2500	130 1300	36 361	0,7 60	7 588	40,1	50	4,9
CA 315 ES	16207	220-240	4,5 160	0,05 1,3	300 2380	170 1600	47 444	0,8 62	8 608	39,7	50	6,9

\* Sound pressure level measured at 3 m in free field conditions with long-cased appliance in delivery mode in accordance with standard EN ISO 9614.

ENERGY DATA FOR REGULATION N° 1254/2014/UE

	UNIT OF MEASURE	CA 100 ES	CA 125 ES	CA 150 ES	CA 150 Q ES
CODE		16200	16201	16203	16202
Supplier's name or trade mark	-	Vortice	Vortice	Vortice	Vortice
SFPint	W(m³/s)	437,72	184,03	211,41	2121,69
Declared typology	-	NRVU-U**	NRVU-U**	NRVU-U**	NRVU-U**
Type of drive	-	MSD***	MSD***	MSD***	MSD***
Type of heat recovery system HRS	-	None	None	None	None
Nominal NRVU flow rate	m³/s	0,079	0,078	0,138	0,078
Effective electric power input	kW	0,08	0,078	0,12	0,084
Face velocity at design flow rate	m/s	10,044	6,338	7,797	4,401
Nominal external pressure (Δps, ext)	Pa	162	235	197	233
Internal pressure drop of ventilation components (Δps,int)	Pa	123	53	63	57
Internal pressure drop of non-ventilation components (Δps,add)	Pa	0	0	0	0
Static efficiency of fans used in accordance with Regulation (EU) N. 327/2011	%	28,1	28,8	29,8	26,8
Declared maximum internal leakage rate of the casing of ventilation units	%	NA*	NA*	NA*	NA*
Declared maximum external leakage rate of the casing of ventilation units	%	2,3	2,4	3,9	2,4
Energy performance energy or classification of the filters	-	NA*	NA*	NA*	NA*
Description of visual filter warning	-	NA*	NA*	NA*	NA*
Casing sound power level	LWA[dB(A)]	NA*	NA*	NA*	NA*

\*NA: Not applicable - \*\*RVU-U: Non Residential Ventilation Unit - Unidirectional - \*\*\*MSD: Multi-Speed Drive

**ENERGY DATA FOR REGULATION N° 1254/2014/UE**

	UNIT OF MEASURE	CA 160 ES	CA 200 ES	CA 250 ES	CA 315 ES
CODE		16204	16205	16206	16207
Supplier's name or trade mark	-	Vortice	Vortice	Vortice	Vortice
SFPint	W(m <sup>3</sup> /s)	145,21	51,37	35,61	24,32
Declared typology	-	NRVU-U**	NRVU-U**	NRVU-U**	NRVU-U**
Type of drive	-	MSD***	MSD***	MSD***	MSD***
Type of heat recovery system HRS	-	None	None	None	None
Nominal NRVU flow rate	m <sup>3</sup> /s	0,140	0,142	0,225	0,236
Effective electric power input	kW	0,119	0,123	0,144	0,172
Face velocity at design flow rate	m/s	6,963	4,518	4,578	3,023
Nominal external pressure ( $\Delta p_{s, ext}$ )	Pa	214	238	203	232
Internal pressure drop of ventilation components ( $\Delta p_{s, int}$ )	Pa	44	15	12	8
Internal pressure drop of non-ventilation components ( $\Delta p_{s, add}$ )	Pa	0	0	0	0
Static efficiency of fans used in accordance with Regulation (EU) N. 327/2011	%	30,3	29,2	33,7	32,9
Declared maximum internal leakage rate of the casing of ventilation units	%	NA*	NA*	NA*	NA*
Declared maximum external leakage rate of the casing of ventilation units	%	3,8	3,8	1,8	1,7
Energy performance energy or classification of the filters	-	NA*	NA*	NA*	NA*
Description of visual filter warning	-	NA*	NA*	NA*	NA*
Casing sound power level	LWA[dB(A)]	NA*	NA*	NA*	NA*

\*NA: Not applicable - \*\*RVU-U: Non Residential Ventilation Unit - Unidirectional - \*\*\*MSD: Multi-Speed Drive

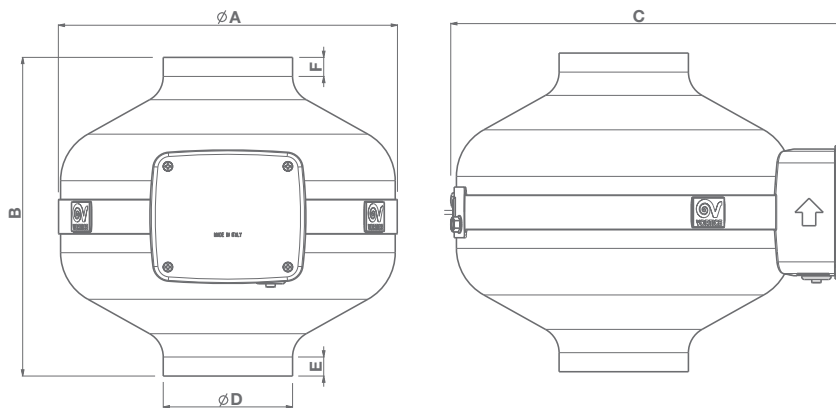
**DIMENSIONS**

MODELS	ØA	B	C	ØD	E	F
CA 100 ES	255	239	330	97	15	15
CA 125 ES	255	239	330	122	23	23
CA 150 ES	347	275	422	147	17	17
CA 150 Q ES	255	239	330	147	30	30
CA 160 ES	347	275	422	157	18	18
CA 200 ES	347	275	422	197	20	17
CA 250 ES	347	267	392	247	30	35
CA 315 ES	406	362	455	315	35	30

Dimensions (mm)



PERFORMANCES CURVES

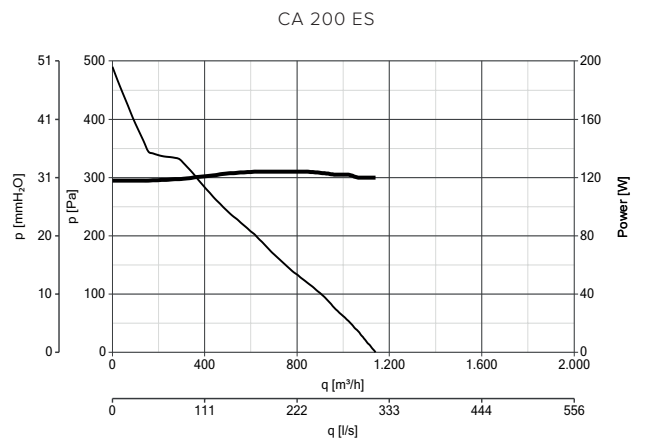
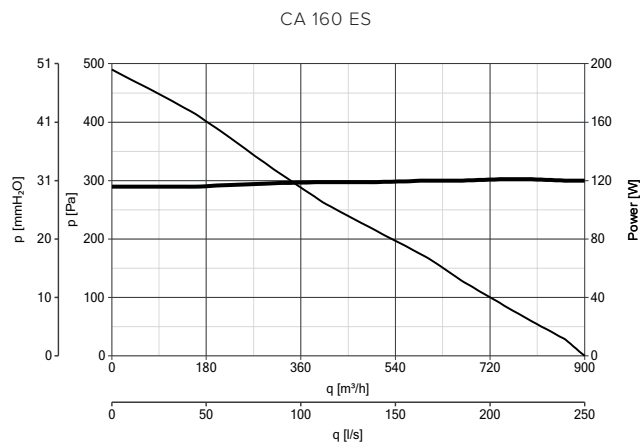
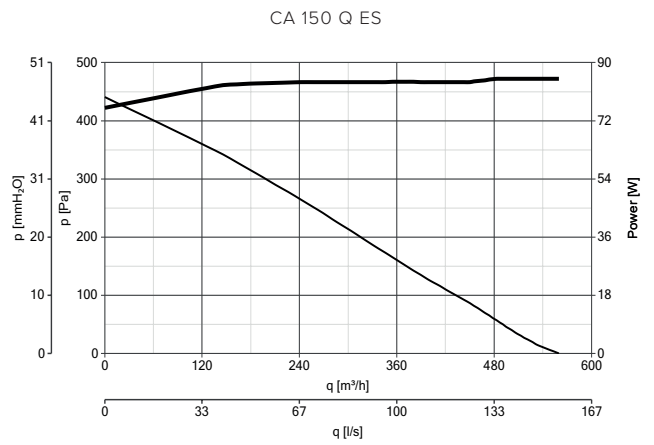
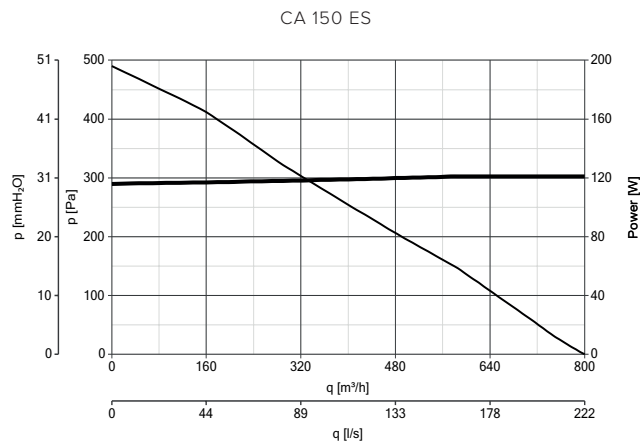
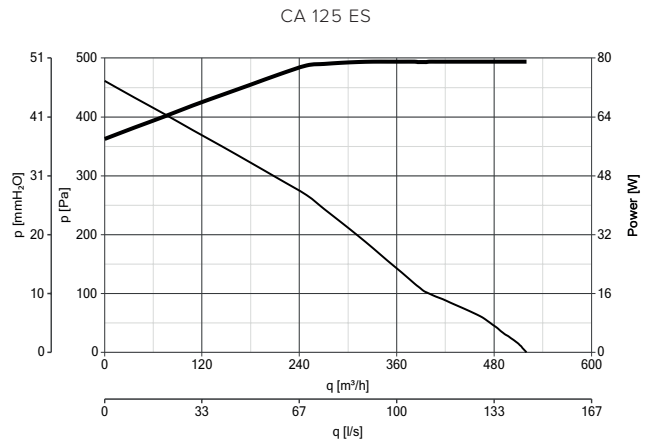
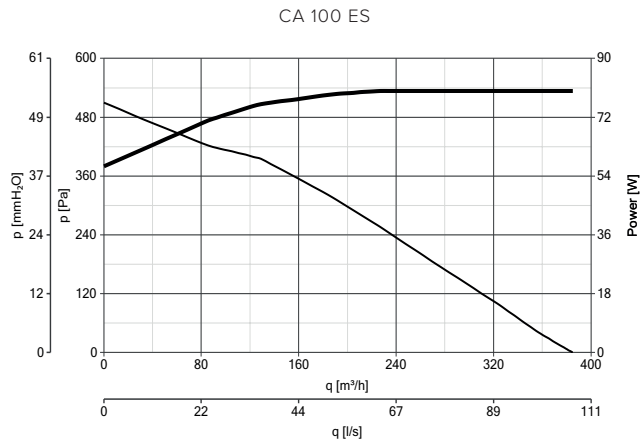

PERFORMANCES CURVES  
 — max  
 — min



## COMMERCIAL VENTILATION

CA ES RANGE

### PERFORMANCES CURVES

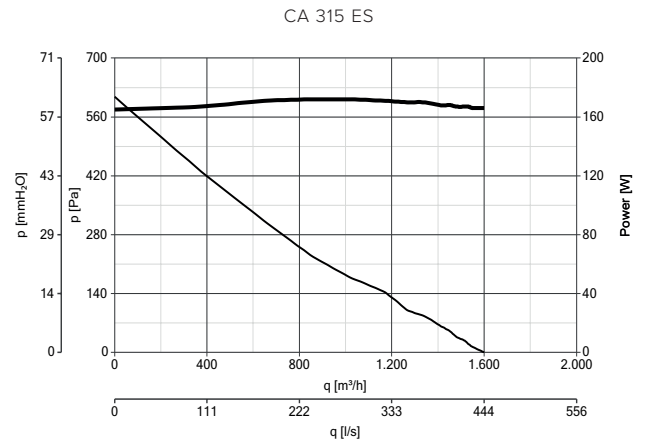
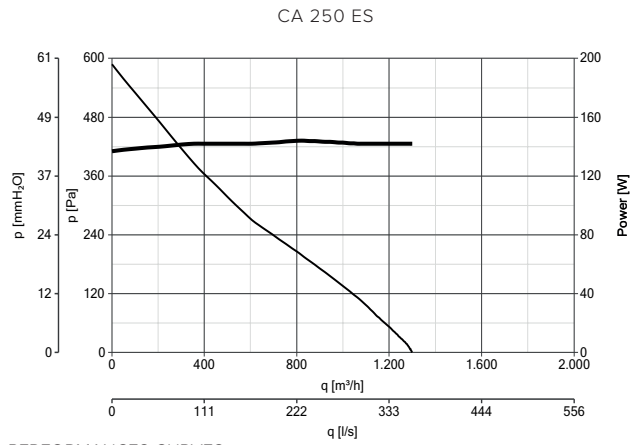





PERFORMANCES CURVES  
— max  
— min





**CONTROLLERS**

MODELS	DESCRIPTION	CODE	PRODUCT
	<b>POT-IT</b> - POTENTIOMETER	12826	ALL PRODUCTS
	<b>POT</b> - POTENTIOMETER	12828	ALL PRODUCTS
	<b>DUO</b> - 2 SPEEDS CONTROLLER	22914	ALL PRODUCTS
	<b>C TEMP</b> - THERMO SWITCH	12992	ALL PRODUCTS
	<b>C SMOKE</b> - AIR QUALITY SENSOR	12993	ALL PRODUCTS
	<b>C HCS</b> - HUMIDISTAT	12994	ALL PRODUCTS
	<b>C PIR</b> - PASSIVE INFRARED SENSOR	12998	ALL PRODUCTS
	<b>C TIMER</b> - TIMER	12999	ALL PRODUCTS

**ACCESSORIES ON REQUEST**

MODELS	DESCRIPTION	CODE	PRODUCT
	<b>CA-MU</b> - MOUNTING BRACKETS	22674	ALL PRODUCTS
		100	22750 16200
		125	22755 16201
		150	22760 16202 - 16203
	<b>CA-G</b> - PROTECTION GRILLE	160	22762 16204
		200	22765 16205
		250	22770 16206
		315	22775 16207

## CA WE D E RANGE

Painted sheet steel mixed flow duct fans for external wall

Painted sheet steel mixed flow duct fans, designed for outdoor installation. The ideal low-visual impact, low-noise ventilation solution for residential or commercial premises (kitchens, toilets, laboratories, bars, restaurants, laundries, shops, etc.).

### VERSIONS

6 models, with nominal diameter between 100 and 200 mm.

### KEY FEATURES

- Built to withstand weathering and high temperatures.
- Designed to minimise noise in the environment.
- Automatic delivery closing to prevent air re-entry and the entry of foreign bodies.
- Fully compliant with Reg. ErP 2018 N. 1253/2014.

### TECHNICAL FEATURES

- Steel sheet front covers that have been painted with polyester paint against aggressive weathering. Grille-protected delivery spigots with automatic spring closure device to prevent the entry of foreign bodies.
- Rear flanges in plastic resin with a mineral-based additive to dampen vibrations and soften noise.
- 3-speed fans that can be set using optional device TRIO-CA (code 12869), composed of:
  - AC motors with thermal overload cut-out and shafts turning on ball bearings to guarantee long lasting (at least 40,000 h) continuous service at the maximum plate temperature.
  - Backward-curve, heat resistant plastic resin blade impellers loaded with glass fibre to combine structural strength and dimensional stability.
- Possibility of connecting to remote environmental temperature, humidity, smoke and presence sensors (optional).
- Performance and safety certified by third party body (IMQ).
- Protection rating from the water: IPX5.
- Insulation Class: II .

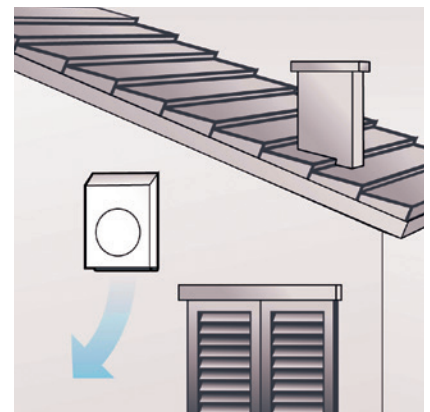
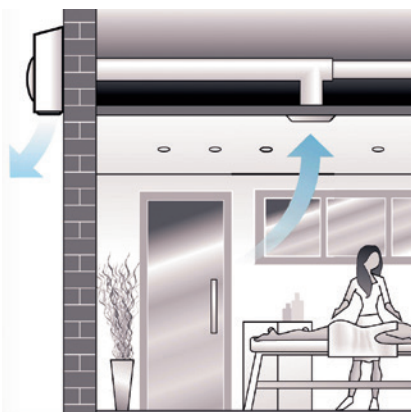





TECHNICAL DATA

Models	Code	V~50	Max Airflow					Max Pressure		LP DB(A) 3m	Max °C	KG
			W min/med/max	A min/med/max	RPM min/med/max	m³/h min/med/max	l/s min/med/max	mmH <sub>2</sub> O min/med/max	Pa min/med/max			
CA 100 WED	16091	220-240	12 24 50	0,13 0,18 0,23	925 1515 2390	68 150 252	18,8 41,6 70	18,3 37,4 38,6	180 366,4 379,4	38,3 - 50,1	60	4,5
CA 125 WED	16092	220-240	12 24 50	0,13 0,18 0,23	880 1400 2350	85 175 328	23,6 48,6 91,1	15,3 34,3 36,7	150,4 336,3 359,5	36,3 - 49,5	60	4,5
CA 150 Q WED	16093	220-240	12 57 50	0,13 0,18 0,23	870 1410 2345	95 190 350	26,3 52,7 97,2	12,4 33,0 36,7	121,6 324 360	37,1 - 49,5	60	4,5
CA 150 WEDE	16087	230	38 100	0,36 0,44 0,44	1015 1455 2520	215 335 625	59,7 93 173,1	27,2 42,1 45,5	267,1 413,6 446,6	23,1 - 42,9	55	8
CA 160 WEDE	16088	230	38 57 100	0,36 0,44 0,44	1060 1475 2490	235 362 660	65,2 100,5 183,3	30,1 43,4 45,2	295,7 425,8 443,9	22 - 37,5	55	8
CA 200 WEDE	16089	230	38 53 100	0,36 0,44 0,44	1100 1460 2495	245 353 680	60 90 188,8	24,9 38,9 44,3	244,4 381,7 434,3	20,9 - 39,1	55	8

\* Sound pressure level measured at 3 m in free field conditions with long-cased appliance in delivery mode in accordance with standard EN ISO 9614.

ENERGY DATA FOR REGULATION N° 1254/2014/UE

	UNIT OF MEASURE	CA 100 WED	CA 125 WED	CA 150 Q WE D	CA 150 WEDE	CA 160 WEDE	CA 200 WEDE
CODE		16091	16092	16093	16087	16088	16089
Supplier's name or trade mark	-	Vortice	Vortice	Vortice	Vortice	Vortice	Vortice
SFPint	W(m³/s)	NA*	NA*	NA*	NA*	NA*	NA*
Declared typology	-	NRVU-U**	NRVU-U**	NRVU-U**	NRVU-U**	NRVU-U**	NRVU-U**
Type of drive	-	MSD***	MSD***	MSD***	MSD***	MSD***	MSD***
Type of heat recovery system HRS	-	None	None	None	None	None	None
Nominal NRVU flow rate	m³/s	0,06328	0,08097	0,09533	0,17219	0,18325	0,18492
Effective electric power input	kW	0,052	0,053	0,053	0,104	0,105	0,103
Face velocity at design flow rate	m/s	8,05678	6,59821	5,39476	9,74421	9,11411	5,88608
Nominal external pressure (Δps, ext)	Pa	471	314	20	69	20	98
Internal pressure drop of ventilation components (Δps,int)	Pa	-234	-121	144	157	187	107
Internal pressure drop of non-ventilation components (Δps,add)	Pa	0	0	0	0	0	0
Static efficiency of fans used in accordance with Regulation (EU) N. 327/2011	%	28,8	29,5	29,5	37,4	36,1	36,8
Declared maximum internal leakage rate of the casing of ventilation units	%	NA*	NA*	NA*	NA*	NA*	NA*
Declared maximum external leakage rate of the casing of ventilation units	%	NA*	NA*	NA*	NA*	NA*	NA*
Energy performance energy or classification of the filters	-	NA*	NA*	NA*	NA*	NA*	NA*
Description of visual filter warning	-	NA*	NA*	NA*	NA*	NA*	NA*
Casing sound power level	LWA[dB(A)]	50	50	50	43	38	39

\*NA: Not applicable - \*\*NRVU-U: Non Residential Ventilation Unit - Unidirectional - \*\*\*MSD: Multi-Speed Drive



## COMMERCIAL VENTILATION

CA ES RANGE

### DIMENSIONS

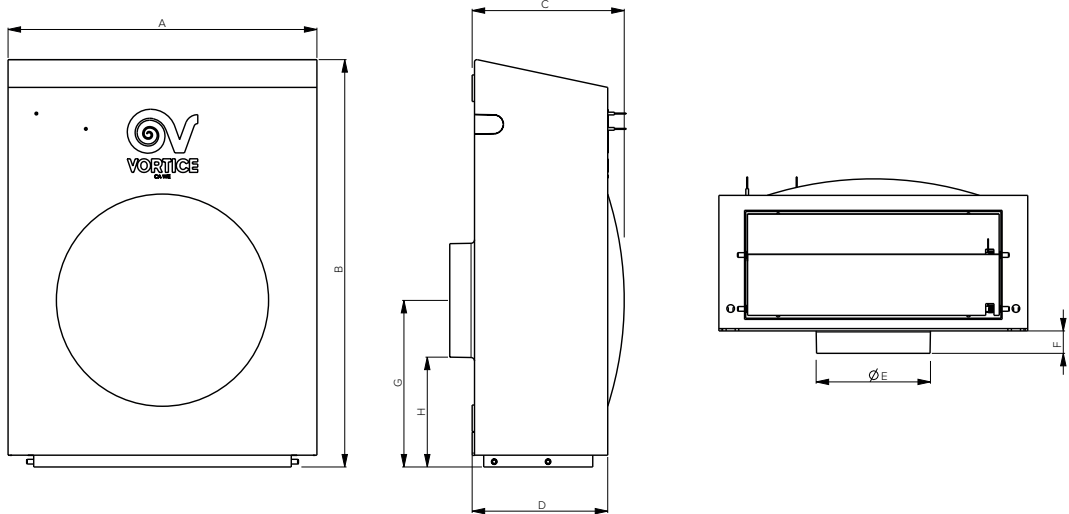

MODELS	A	B	C	D	ØE	F	G	H
CA 100 WED	262	345	127	113	97	20	142	93
CA 125 WED	262	345	127	113	122	20	142	80,5
CA 150 Q WED	262	345	127	113	147	20	142	68
CA 150 WE DE	360	430	173	155	147	20	180	106
CA 160 WE DE	360	430	173	155	157	20	180	101
CA 200 WE DE	360	430	173	155	157	20	180	81

Dimensions (mm)

### PERFORMANCES CURVES

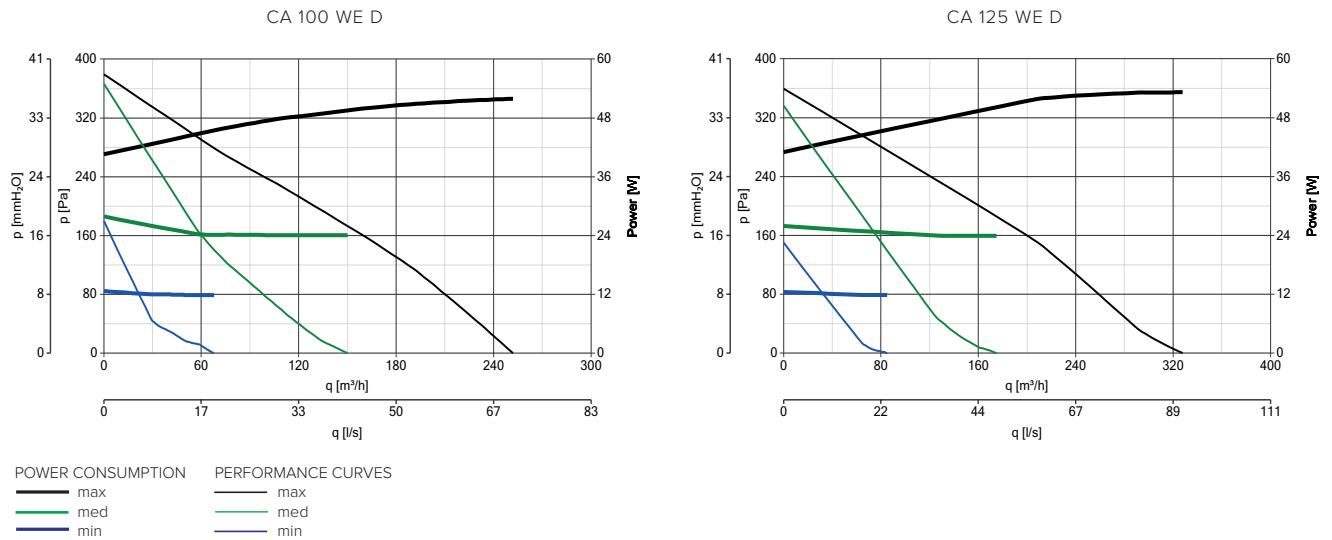



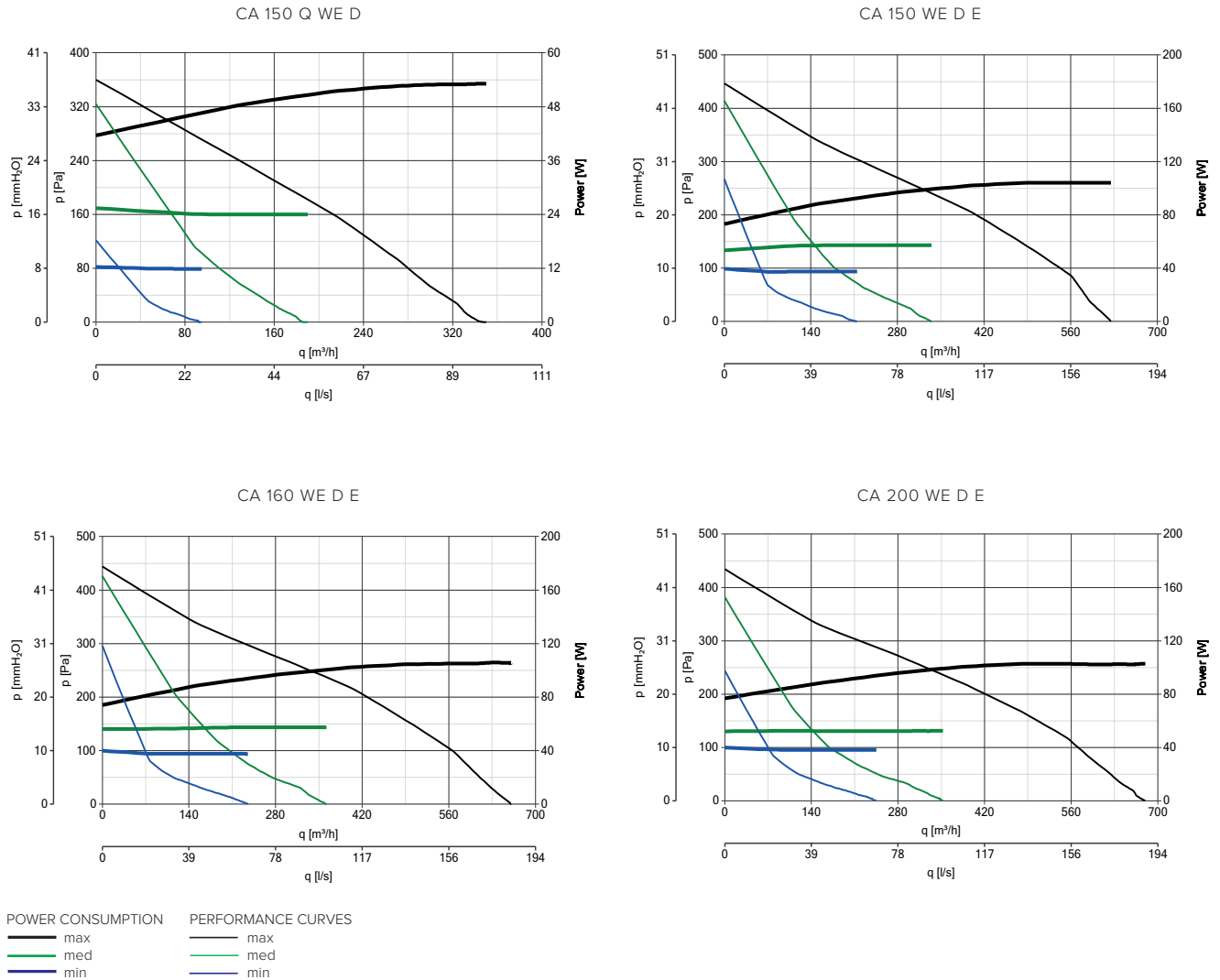

PERFORMANCES CURVES



CONTROLLERS

MODELS	DESCRIPTION	CODE	PRODUCT
	<b>C 1.5</b> - ELECTRONIC SPEED CONTROLLER 1.5 A	12966	ALL PRODUCTS
	<b>C 2.5</b> - ELECTRONIC SPEED CONTROLLER 2.5 A	12967	ALL PRODUCTS
	<b>KIT SCB</b> - BUILT-IN CONTROLLER ADAPTOR	22481	12966 - 12967
	<b>TRIO</b> - 3 SPEED SWITCH FOR WALL AND FLUSH MOUNTING INSIDE UNI 503 STANDARD ELECTRIC BOXES	12869	ALL PRODUCTS

## CA MD E W RANGE

### Steel sheet mixed flow wall fans

Steel sheet mixed flow wall fans. Installed at the end of the ventilation duct, effectively meet the ventilation needs of commercial or industrial premises (laboratories, bars, restaurants, laundries, gyms, etc.).

#### VERSIONS

8 models, with nominal diameter between 100 and 315 mm.

#### KEY FEATURES

- Built to withstand weathering and high temperatures.
- Extremely reliable and low maintenance.
- Wide continuous operation temperature range.
- Fully compliant with Reg. ErP 2018 N. 1253/2014.

#### TECHNICAL FEATURES

- Pickled, phosphate-coated steel sheet casing and wall fixing plates that have been painted with polyester paint against aggressive weathering.
- Motor-holder built into the boxes housing the mains connection terminals and the flow conditioner fins, constructed in self-extinguishing plastic resin (V0).
- 3-speed fans that can be set using optional device TRIO-CA (code 12869), composed of:
  - AC motors with thermal overload cut-out and shafts turning on ball bearings to guarantee long lasting continuous service (at least 30,000 h) at the maximum plate temperature.
  - Backward-curve, heat resistant plastic resin blade impellers loaded with glass fibre to combine structural strength and dimensional stability.
- Possibility of connecting to remote environmental temperature, humidity, smoke and presence sensors (optional).
- Performance and safety certified by third party body (IMQ).
- Protection rating from the water: IP44 (appliance ducted in extraction and delivery).
- Insulation Class: II .



TECHNICAL DATA

Models	Code	V~50/60					Max Airflow		Max Pressure		LP DB(A) 3m*	Max °C	KG
			W min/med/max	A min/med/max	RPM min/med/max	m³/h min/med/max	l/s min/med/max	mmH <sub>2</sub> O min/med/max	Pa min/med/max				
CA 100 MD E W	16120	220-240	25 24 85	0,13 0,18 0,23	970 1650 2450	160 262 400	44,4 72,7 111,1	26,8 38,8 38,8	262,2 380,1 380,1	19,2 - 35,7	50	3,7	
CA 125 MD E W	16121	220-240	25 24 85	0,13 0,18 0,23	935 1660 2445	160 295 445	44,4 81,9 123,6	13,9 34,5 36,2	136,5 338,0 355,9	25,5 - 39,4	50	3,8	
CA 150 Q MD E W	16122	220-240	25 24 85	0,13 0,18 0,23	965 1615 2435	168 295 455	46,6 81,9 126,3	7,1 21 32,5	69,5 206,0 318,7	28,3 - 38	50	4,8	
CA 150 MD E W	16133	220-240	39 50 85	0,34 0,35 0,38	1740 2230 2690	400 510 617	111,1 141,6 171,3	31,6 40,0 43,8	310,4 392,6 429,7	41,4 53,3	55	4,8	
CA 160 MD E W	16134	220-240	38 50 85	0,35 0,35 0,38	1570 2120 2680	385,8 515 665	107,1 143 184,7	28 37,8 42,4	275,1 370,8 416,7	43 - 53	55	6,2	
CA 200 MD E W	16135	220-240	39 50 90	0,35 0,35 0,40	1455 1960 2630	455 635 825	126,3 176,3 229,1	34,3 42,2 44	337,1 413,6 432,3	37,9 - 48,2	55	6	
CA 250 MD E W	16136	220-240	48 79 130	0,48 0,57 0,55	1340 2015 2675	500 760 1030	138,8 211,1 286,1	34,9 52,8 55,9	342,3 518,4 548,3	31,6 - 50,8	50	6,2	
CA 315 MD E W	16137	220-240	48 79 120	0,48 0,57 0,55	1335 2020 2670	490 765 1030	136,1 212,5 286,1	35,7 54,5 58,2	350,5 534,8 570,8	41,2 - 51,4	50	9,4	

\* Sound pressure level measured at 3 m in free field conditions with long-cased appliance in delivery mode in accordance with standard EN ISO 9614.

ENERGY DATA FOR REGULATION N° 1254/2014/UE

	UNIT OF MEASURE	CA 100 MD E W	CA 125 MD E W	CA 150 Q MD E W	CA 150 MD E W
CODE		16120	16121	16122	16133
Supplier's name or trade mark	-	Vortice	Vortice	Vortice	Vortice
SFPint	W(m³/s)	NA*	NA*	NA*	NA*
Declared typology	-	NRVU-U**	NRVU-U**	NRVU-U**	NRVU-U**
Type of drive	-	MSD***	MSD***	MSD***	MSD***
Type of heat recovery system HRS	-	None	None	None	None
Nominal NRVU flow rate	m³/s	0,10994	0,12206	0,12328	0,17025
Effective electric power input	kW	0,050	0,050	0,050	0,081
Face velocity at design flow rate	m/s	13,99856	9,94598	6,97610	9,63418
Nominal external pressure (Δps, ext)	Pa	88	108	137	59
Internal pressure drop of ventilation components (Δps,int)	Pa	44	-6	-40	171
Internal pressure drop of non-ventilation components (Δps,add)	Pa	0	0	0	0
Static efficiency of fans used in accordance with Regulation (EU) N. 327/2011	%	29,0	24,9	23,9	48,2
Declared maximum internal leakage rate of the casing of ventilation units	%	NA*	NA*	NA*	NA*
Declared maximum external leakage rate of the casing of ventilation units	%	NA*	NA*	NA*	NA*
Energy performance energy or classification of the filters	-	NA*	NA*	NA*	NA*
Description of visual filter warning	-	NA*	NA*	NA*	NA*
Casing sound power level	LWA[dB(A)]	36	39	38	53

\*NA: Not applicable - \*\*RVU-U: Non Residential Ventilation Unit - Unidirectional - \*\*\*MSD: Multi-Speed Drive



## COMMERCIAL VENTILATION

CA MD E W RANGE

### ENERGY DATA FOR REGULATION N° 1254/2014/UE

	UNIT OF MEASURE	CA 160 MD E W	CA 200 MD E W	CA 250 MD E W	CA 315 MD E W
CODE		16134	16135	16136	16137
Supplier's name or trade mark	-	Vortice	Vortice	Vortice	Vortice
SFPint	W(m³/s)	NA*	NA*	NA*	NA*
Declared typology	-	NRVU-U**	NRVU-U**	NRVU-U**	NRVU-U**
Type of drive	-	MSD***	MSD***	MSD***	MSD***
Type of heat recovery system HRS	-	None	None	None	None
Nominal NRVU flow rate	m³/s	0,18356	0,22633	0,28222	0,28083
Effective electric power input	kW	0,083	0,088	0,127	0,127
Face velocity at design flow rate	m/s	9,12931	7,20442	5,74939	3,60361
Nominal external pressure ( $\Delta p_{s, ext}$ )	Pa	49	128	108	128
Internal pressure drop of ventilation components ( $\Delta p_{s, int}$ )	Pa	158	-16	25	8
Internal pressure drop of non-ventilation components ( $\Delta p_{s, add}$ )	Pa	0	0	0	0
Static efficiency of fans used in accordance with Regulation (EU) N. 327/2011	%	45,9	28,7	29,6	30,0
Declared maximum internal leakage rate of the casing of ventilation units	%	NA*	NA*	NA*	NA*
Declared maximum external leakage rate of the casing of ventilation units	%	NA*	NA*	NA*	NA*
Energy performance energy or classification of the filters	-	NA*	NA*	NA*	NA*
Description of visual filter warning	-	NA*	NA*	NA*	NA*
Casing sound power level	LWA[dB(A)]	53	48	51	51

\*NA: Not applicable - \*\*RVU-U: Non Residential Ventilation Unit - Unidirectional - \*\*\*MSD: Multi-Speed Drive







**DIMENSIONS**

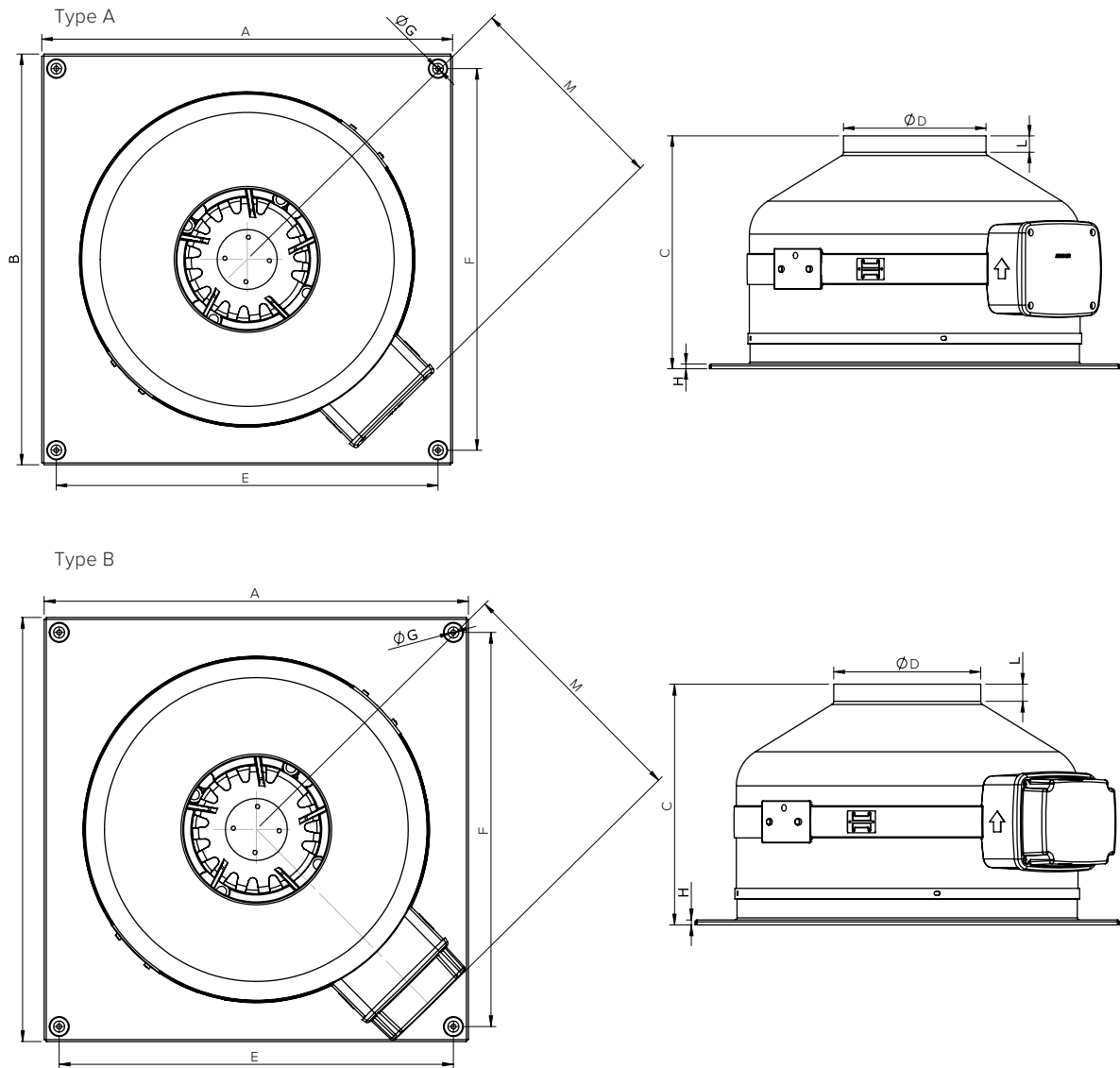

MODELS	TYPE	ØA	B	C	ØD	E	F	G	H	L	M
CA 100 MD E W	B	334	334	210	97	304	304	5	5	15	198
CA 125 MD E W	B	334	334	210	122	304	304	5	5	23	198
CA 150 Q MD E W	B	334	334	210	147	304	304	5	5	30	198
CA 150 MD E W	A	424	424	245	147	394	394	5	5	17	220
CA 160 MD E W	A	424	424	245	157	394	394	5	5	18	220
CA 200 MD E W	A	424	424	245	197	394	394	5	5	20	220
CA 250 MD E W	B	424	424	237	247	394	394	5	5	38	250
CA 315 MD E W	A	489	489	260	312	459	459	5	5	36	252

Dimensions (mm)



# COMMERCIAL VENTILATION

CA MD E W RANGE

## PERFORMANCES CURVES

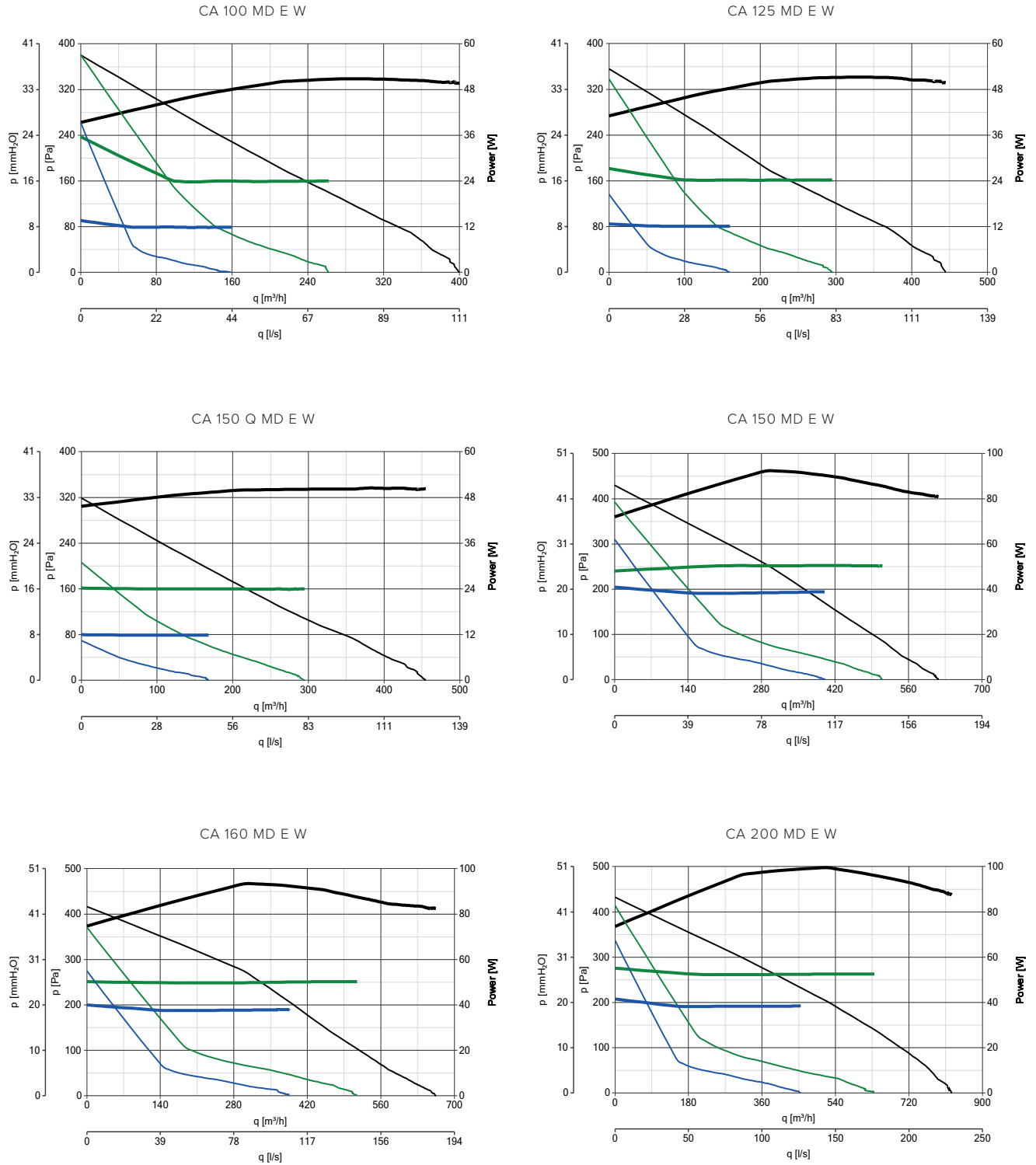



POWER CONSUMPTION      PERFORMANCE CURVES  
 — max                      — max  
 — med                     — med  
 — min                     — min

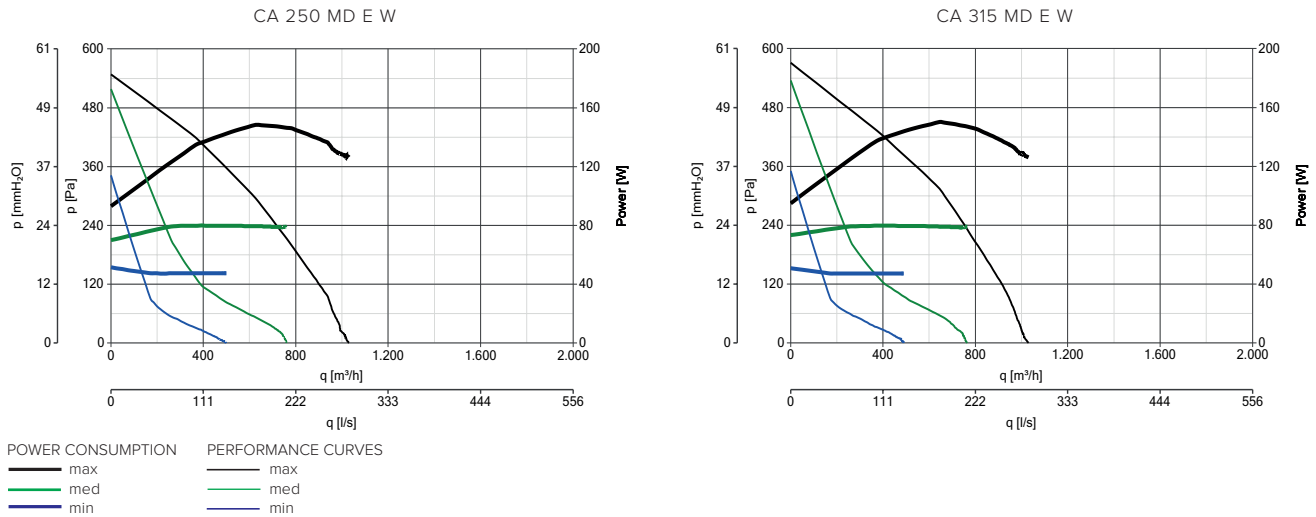

PERFORMANCES CURVES



CONTROLLERS

MODELS	DESCRIPTION	CODE	PRODUCT
	<b>C 1.5</b> - ELECTRONIC SPEED CONTROLLER 1.5 A	12966	ALL PRODUCTS
	<b>C 2.5</b> - ELECTRONIC SPEED CONTROLLER 2.5 A	12967	ALL PRODUCTS
	<b>KIT SCB</b> - BUILT-IN CONTROLLER ADAPTOR	22481	12966 - 12967
	<b>TRIO</b> - 3 SPEED SWITCH FOR WALL AND FLUSH MOUNTING INSIDE UNI 503 STANDARD ELECTRIC BOXES	12869	ALL PRODUCTS

ACCESSORIES ON REQUEST

MODELS	DESCRIPTION	CODE	PRODUCT
		100	22750
		125	22755
		150	22760
		160	22762
		200	22765
		250	22770
		315	22775
	<b>CA-G</b> - PROTECTION GRILLE	16120	16121
		16122 - 16133	16134
		16135	16136
		16137	

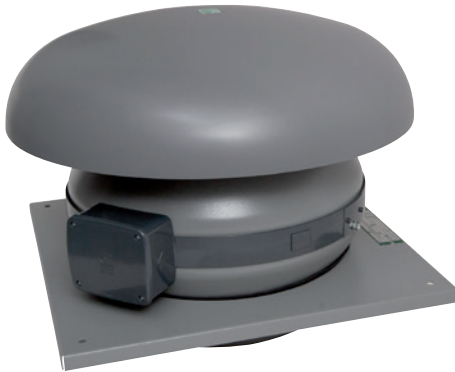

## CA MD E RF RANGE

Painted steel sheet mixed flow roof fans

Painted steel sheet mixed flow roof fans. Installed at the end of the ventilation duct, effectively and economically meet the ventilation needs of commercial or industrial premises (laboratories, bars, restaurants, laundries, gyms, etc.) with a roof-mounted exhaust.

### VERSIONS

8 models, with nominal diameter between 100 and 315 mm.

### KEY FEATURES

- Excellent price-to-performance ratio
- Built to withstand weathering and high temperatures.
- Extremely reliable and low maintenance.
- Wide continuous operation temperature range.
- Fully compliant with Reg. ErP 2018 N. 1253/2014.

### TECHNICAL FEATURES

- Pickled, phosphate-coated steel sheet casing and roof fixing plates that have been painted with polyester paint against aggressive weathering.
- Motor-holder built into the boxes housing the mains connection terminals and the flow conditioner fins, constructed in self-extinguishing plastic resin (V0).
- Plastic resin covering that is resistant to weathering and to ageing induced by UV rays ("UV resistant").
- 3-speed fans that can be set using optional device TRIO-CA (code 12869), composed of:
  - AC motors with thermal overload cut-out and shafts turning on ball bearings to guarantee long lasting continuous service (at least 30,000 h) at the maximum plate temperature.
  - Centrifugal impellers with backward curved blades in heat-resistant plastic resin loaded with glass fibres to combine structural strength and dimensional stability.
- Possibility of connecting to remote environmental temperature, humidity, smoke and presence sensors (optional).
- Performance and safety certified by third party body (IMQ).
- Protection rating from dusts and water: IP44 (appliance ducted in extraction and delivery).
- Insulation Class: II .



TECHNICAL DATA

Models	Code	V~50/60	Max Airflow					Max Pressure		LP DB(A) 3m*	Max °C	KG
			W min/med/max	A min/med/max	RPM min/med/max	m³/h min/med/max	l/s min/med/max	mmH₂O min/med/max	Pa min/med/max			
CA 100 MD E RF	16140	220-240	12 24 50	0,13 0,18 0,23	900 1555 2405	95 167 265	26,3 46 73,6	27,7 39,7 39,7	272,2 389,3 389,3	27,3 - 37,5	50	4,6
CA 125 MD E RF	16141	220-240	12 24 50	0,13 0,18 0,23	915 1538 2405	118 200 312	32,7 55,5 86,6	16,5 34,8 36,3	161,8 340,8 356,1	21,5 - 40,2	50	4,6
CA 150 Q MD E RF	16142	220-240	12 24 50	0,13 0,18 0,23	963 1608 2430	122 207 312	33,8 57,5 86,6	7,2 21,7 31,4	70,7 212,8 307,9	23,8 - 37,5	50	7,5
CA 150 MD E RF	16183	220-240	33 45 85	0,33 0,37 0,39	1240 1660 2630	230 310 490	63,8 86,1 136,1	31,3 41,2 44	307,6 404,7 432,1	24,6 - 43,8	55	7,5
CA 160 MD E RF	16184	220-240	33 45 88	0,33 0,37 0,39	1300 1740 2655	245 325 500	68 90 138	20,5 32,9 40,5	201 322,6 400	30,4 - 44,8	55	9
CA 200 MD E RF	16185	220-240	33 45 95	0,33 0,37 0,42	1156 1465 2555	310 395 700	86,1 109,7 194,7	31,9 41,3 44,9	313,4 405,5 440,6	23 - 31,7	55	9,6
CA 250 MD E RF	16186	220-240	48 80 130	0,47 0,57 0,57	1195 1752 2665	385 570 850	106,9 158,3 236,1	39,1 53,2 56,3	384,1 521,5 552,2	28,6 - 43,8	50	10
CA 315 MD E RF	16187	220-240	48 80 130	0,48 0,57 0,57	1186 1755 2590	370 565 865	102,7 156,9 240,2	37,6 55,2 58,5	368,9 542,1 573,7	32,8 - 40,7	50	12

\* Sound pressure level measured at 3 m in free field conditions with long-cased appliance in delivery mode in accordance with standard EN ISO 9614.

ENERGY DATA FOR REGULATION N° 1254/2014/UE

	UNIT OF MEASURE	CA 100 MD E RF	CA 125 MD E RF	CA 150 Q MD E RF	CA 150 MD E RF
CODE		16140	16141	16142	16183
Supplier's name or trade mark	-	Vortice	Vortice	Vortice	Vortice
SFPint	W(m³/s)	NA*	NA*	NA*	NA*
Declared typology	-	NRVU-U**	NRVU-U**	NRVU-U**	NRVU-U**
Type of drive	-	MSD***	MSD***	MSD***	MSD***
Type of heat recovery system HRS	-	None	None	None	None
Nominal NRVU flow rate	m³/s	0,06967	0,08597	0,08589	0,13508
Effective electric power input	kW	0,051	0,051	0,050	0,089
Face velocity at design flow rate	m/s	8,87024	7,00565	4,86032	7,64415
Nominal external pressure (Δps, ext)	Pa	108	29	29	69
Internal pressure drop of ventilation components (Δps,int)	Pa	110	154	154	213
Internal pressure drop of non-ventilation components (Δps,add)	Pa	0	0	0	0
Static efficiency of fans used in accordance with Regulation (EU) N. 327/2011	%	29,8	30,8	31,4	42,8
Declared maximum internal leakage rate of the casing of ventilation units	%	NA*	NA*	NA*	NA*
Declared maximum external leakage rate of the casing of ventilation units	%	NA*	NA*	NA*	NA*
Energy performance energy or classification of the filters	-	NA*	NA*	NA*	NA*
Description of visual filter warning	-	NA*	NA*	NA*	NA*
Casing sound power level	LWA[dB(A)]	38	40		44

\*NA: Not applicable - \*\*RVU-U: Non Residential Ventilation Unit - Unidirectional - \*\*\*MSD: Multi-Speed Drive

**DIMENSIONS**

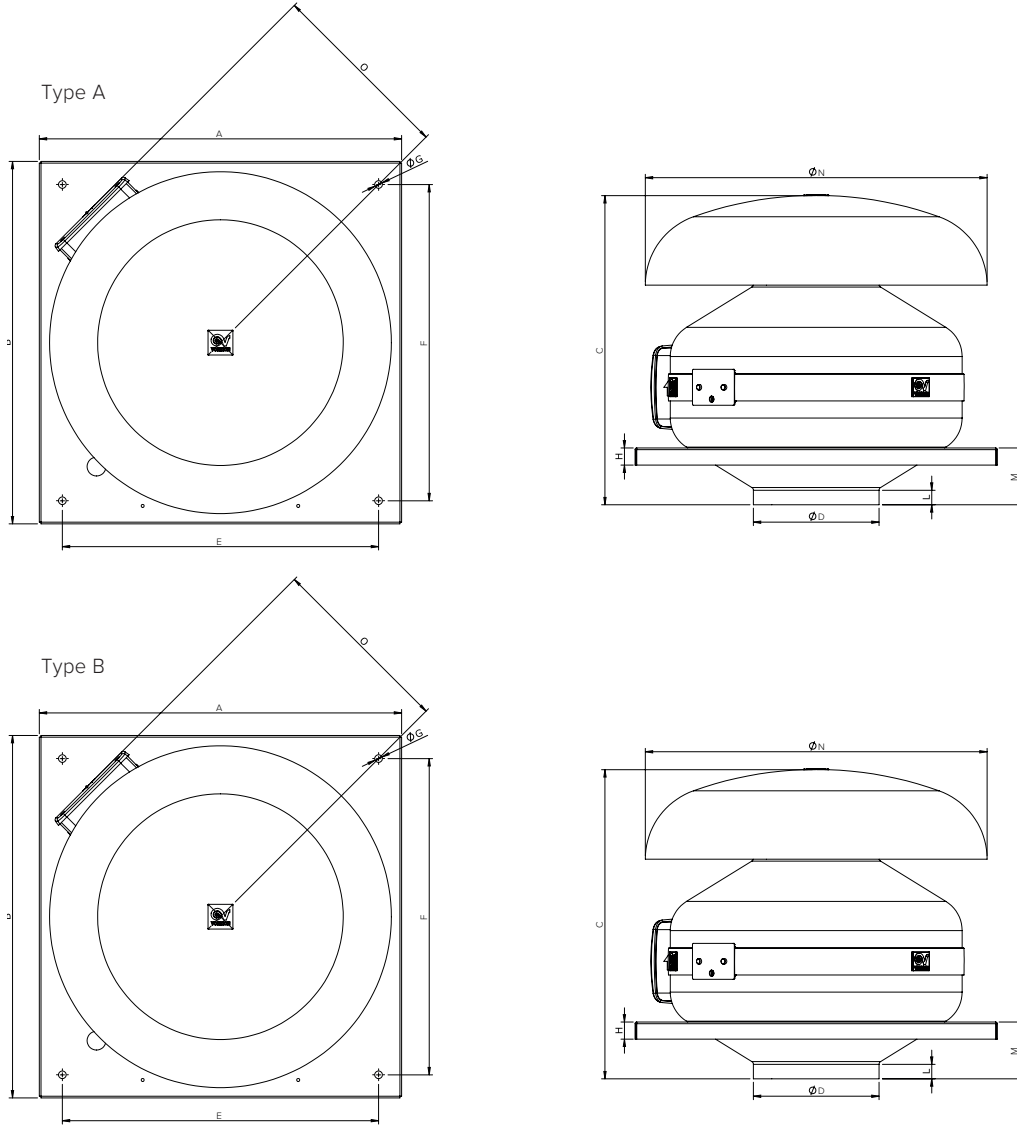

MODELS	TYPE	A	B	C	ØD	E	F	ØG	H	L	M	ØN	O
CA 100 MD E RF	B	334	334	305	97	280	280	9	20	15	35	300	198
CA 125 MD E W	B	334	334	305	122	280	280	9	20	23	35	300	198
CA 150 Q MD E RF	B	334	334	305	147	280	280	9	20	30	35	300	198
CA 150 MD E RF	A	424	424	365	147	370	370	9	20	17	47	400	220
CA 160 MD E RF	B	424	424	365	157	370	370	9	20	18	47	400	250
CA 200 MD E RF	B	424	424	365	197	370	370	9	20	20	49	400	250
CA 250 MD E RF	A	489	489	367	247	435	435	9	20	38	41	400	220
CA 315 MD E RF	A	489	489	415	312	435	435	9	20	36	65	534	250

Dimensions (mm)





PERFORMANCES CURVES

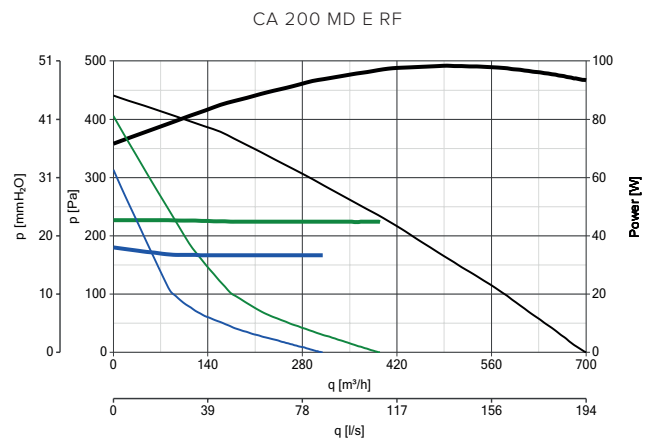
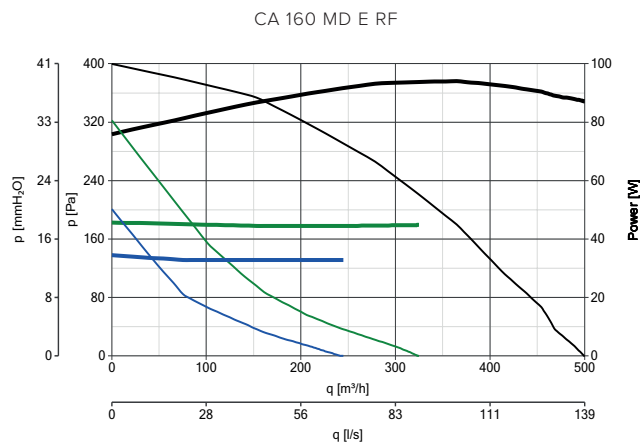
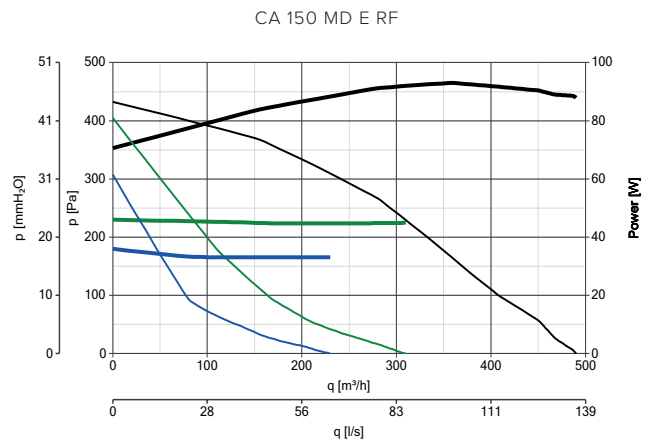
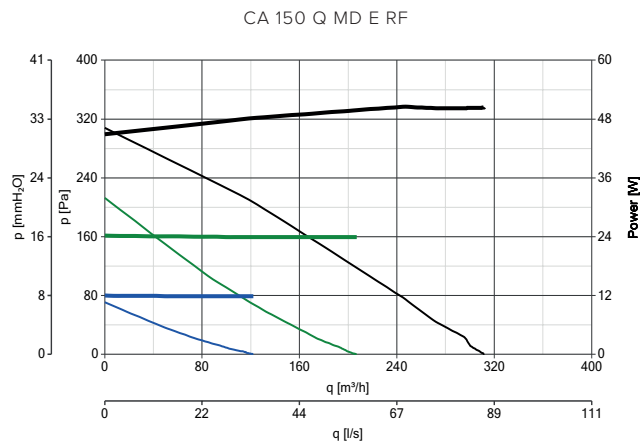
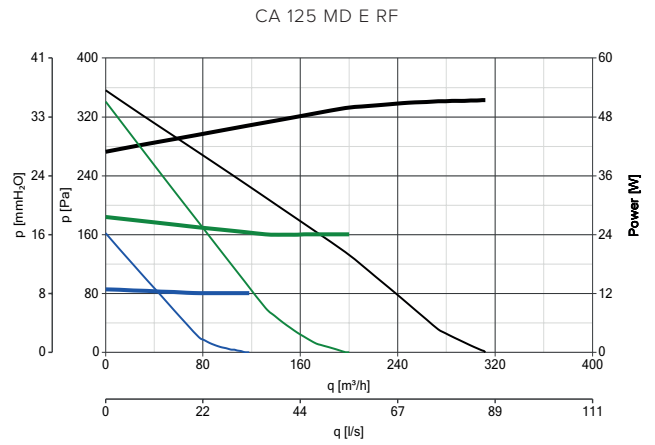
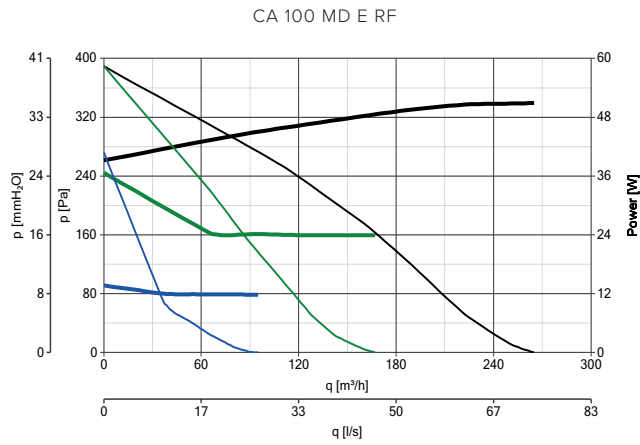

POWER CONSUMPTION  
 — max  
 — med  
 — min

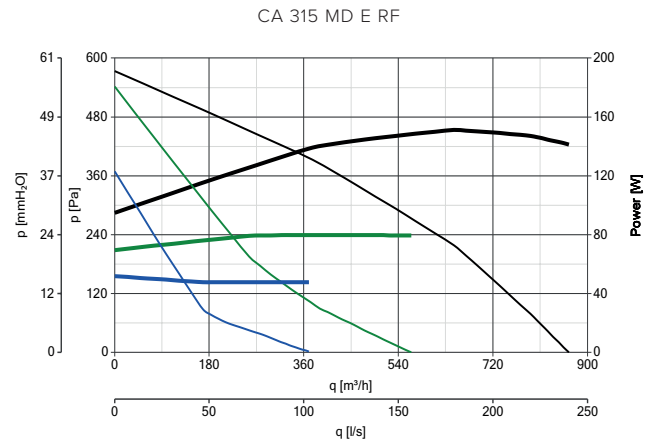
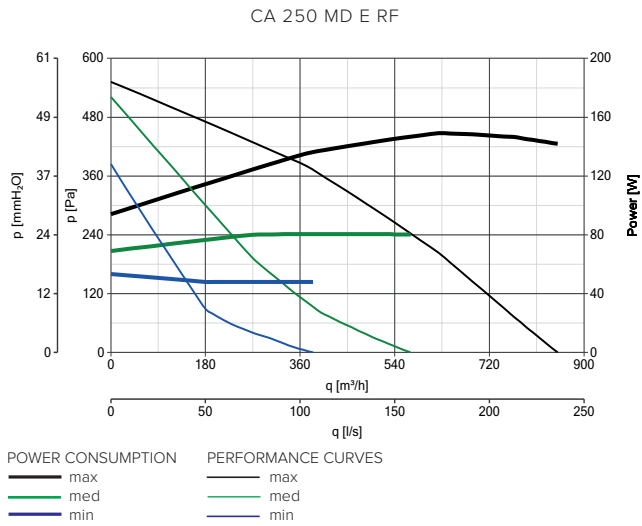

PERFORMANCE CURVES  
 — max  
 — med  
 — min

PERFORMANCES CURVES







**CONTROLLERS**

MODELS	DESCRIPTION	CODE	PRODUCT
	<b>C 1.5</b> - ELECTRONIC SPEED CONTROLLER 1.5 A	12966	ALL PRODUCTS
	<b>C 2.5</b> - ELECTRONIC SPEED CONTROLLER 2.5 A	12967	ALL PRODUCTS
	<b>KIT SCB</b> - BUILT-IN CONTROLLER ADAPTOR	22481	12966 - 12967
	<b>TRIO</b> - 3 SPEED SWITCH FOR WALL AND FLUSH MOUNTING INSIDE UNI 503 STANDARD ELECTRIC BOXES	12869	ALL PRODUCTS

**ACCESSORIES ON REQUEST**

MODELS	DESCRIPTION	CODE	PRODUCT
		100 22750	16140
		125 22755	16141
		150 22760	16142 - 16183
	<b>CA-G</b> - PROTECTION GRILLE	160 22762	16184
		200 22765	16185
		250 22770	16186
		315 22775	16187
	<b>CARF-C 125</b> - SUB-FRAME	22543	16140 - 16141
	<b>CARF-C 150/160/200</b> - SUB-FRAME	22544	16142 - 16183 - 16184 - 16185
	<b>CARF-C 250/315</b> - SUB-FRAME	22545	16186 - 16187

## CA IN-LINE RANGE

CA IN-LINE are compact centrifugal in-line fans designed to extract low to larger air volumes from residential, commercial and industrial premises like service rooms, wet rooms, offices, laboratories, shops, bars, restaurants, laundries, etc...

Their installation in industrial areas is favored by robust construction (casings are made of galvanized steel sheet) and high (IP44) level of protection against dust and water when ducted. Thanks to their very short height, CA IN-LINE units are ideal for mounting in short false ceilings, while they are fully compatible with installation on wall and ceilings; on this respect, integrated brackets facilitate their commissioning.

Swing-out motorfans facilitate cleaning and extraordinary maintenance. Alternative speed settings (AC versions are equipped with 3 speed motors, while EC models can be adjusted through 0-10 V potentiometers) offer the best compromise among performances, consumption and noise.

### COMPOSITION RANGE

CA IN-LINE range consists of 19 models, nominal diameters between 100 mm and 200 mm, divided into 3 series: CA IN-LINE, CA IN-LINE QUIET and CA IN-LINE QUIET ES, each with alternative type of motorfans and different levels of soundproofing.

### KEY FEATURES

- Easy installation in small spaces thanks to short height.
- Flexible installation, horizontal, vertical and slanted, on walls, ceilings and in false-ceilings, even in the presence of high concentrations of dust or water.
- Quick commissioning: all electrical connections are located inside a highly (IP55) protected box outside the casing.
- Easy maintenance, thanks to the motorfans fixed to the lower covers hinged to the casings to allow them to rotate outwardly.
- Possibility to conveniently adapt the performance according to real needs, for the best balance of airflow, consumption and noise emissions.
- Very low noise emissions (CA IN-LINE QUIET and CA IN-LINE QUIET ES).
- Very low consumptions (CA IN-LINE QUIET ES).
- Long lasting reliability, thanks to high quality, virtually maintenance free motors.





# CONSTRUCTION RANGE



**LONG LIFE** 30.000 h

### 1. TERMINAL BOXES

Highly (IP55) protected against dust and water, are located outside the casings and fitted to power cables to allow their positioning in the most appropriate place, depending on specific installation needs.

### 2. ROBUST GALVANIZED STEEL SHEET CASINGS

Inner sound proof lining ( material and thickness change with the series) to reduce noise emissions. Protection grade IP44 when ducted.

### 3. CIRCULAR SPIGOTS

On supply and extract, equipped with double lip rubber gaskets to avoid air leakages, fitting into standard ducts.

### 5. GALVANIZED STEEL SHEET BRACKETS

Directly fixed to the casing for faster installation.

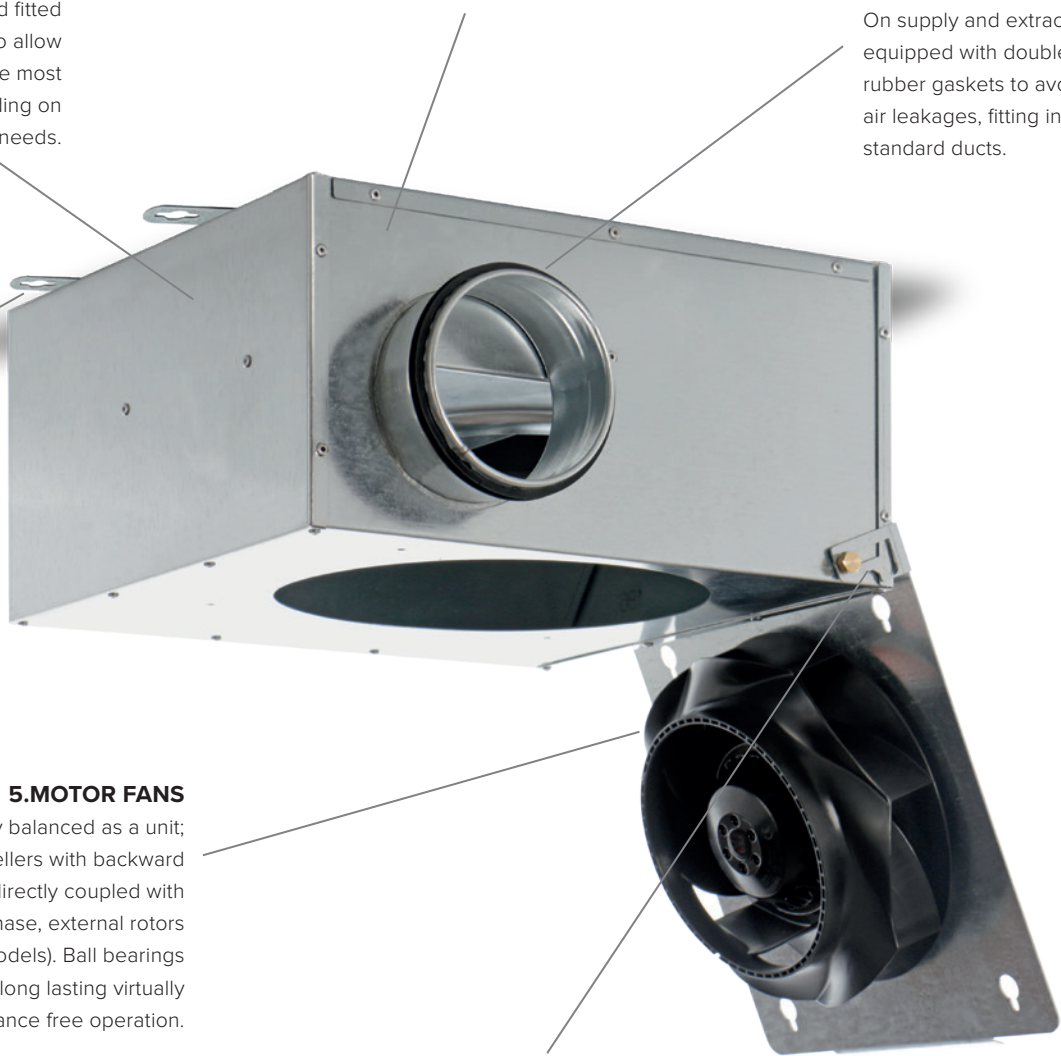

### 5. MOTOR FANS

Dynamically balanced as a unit; centrifugal impellers with backward curved blades directly coupled with single-phase, external rotors (EC in ES models). Ball bearings to grant long lasting virtually maintenance free operation.

### 4. COWER COVERS

Hinged to the casings and free to rotatable downwards suitable backwards to facilitate access to the attached motorfans, thus granting easier cleaning and extraordinary maintenance.



## CA IN-LINE RANGE

Compact flat in-line centrifugal fans

Suitable for indoor wall-mounted applications at the end of ventilation ducts in residential and industrial environments as factories, hospitals, gyms, restaurants, etc...

### TECHNICAL FEATURES

- Casings made of galvanized steel sheet, robust and resistant to corrosion, highly (IP44) protected against dust and water when ducted; inner sound proof lining, consisting of 10 mm thick PE foam, to reduce noise emissions into adjacent rooms.
- Fixing brackets, made of galvanized steel sheet, integrated in the casings to speed up installation.
- Circular spigots for connection to standard commercial hoses, fitted with a double lip rubber gasket for perfect air tightness.
- Highly efficient backward curved centrifugal impellers directly coupled to single-phase, 3 speed, protected against overheating, external rotor motors. Ball bearings to grant long lasting (at least 30.000 h) continuous duty at the maximum rated temperature. Speed setting through Vortice speed switches (optional); speed control from 0-100% by means of Vortice's electronic speed controllers (optional).
- Electrical connection boxes, made of plastic resin, shock proof and resistant to aggressive agents, with a very high (IP55 protection against dust and water).
- Protection against dust and water: IP44 (when ducted).
- Electric insulation class: I (grounding mandatory).

### TECHNICAL DATA

Models	Code	V 50/60Hz	W* max/mid/min			A max	Max airflow*						Max pressure*			Max* °C	Kg			
							m <sup>3</sup> /h max/mid./min.			l/s max/mid/min			mmH <sub>2</sub> O max/mid/min					Pa max/mid/min		
CA-IL 100	16250	230	50	33	18	0,22	250	200	120	69	55	33	35,7	32,8	17,7	350	315	170	40	5,4
CA-IL 125	16251	230	50	33	18	0,22	310	250	160	86	69	44	35,7	33,8	19,7	350	325	190	40	5,4
CA-IL 150 Q	16252	230	50	33	18	0,23	350	280	160	97	78	44	30,6	29,1	15,1	300	280	145	40	5,8
CA-IL 150	16254	230	100	65	49	0,44	460	320	230	128	89	64	44,1	33,3	19,2	435	320	185	40	6,2
CA-IL 160 Q	16253	230	50	33	18	0,23	350	250	160	97	69	44	30,6	27	22,9	300	260	220	40	6
CA-IL 160	16255	230	100	70	50	0,46	460	330	250	128	92	69	45,9	42,7	32,2	450	410	310	40	6
CA-IL 200	16256	230	140	85	50	0,61	830	600	410	231	167	114	55,3	50	34,8	550	480	335	40	9,4

\* Values referred to 230V/50Hz



ENERGY DATA FOR REGULATION N° 1254/2014/UE

	UNIT OF MEASURE	CA-IL 100	CA-IL 125	CA-IL 150 Q	CA-IL 150
<b>CODE</b>		16250	16251	16252	16254
Supplier's name or trade mark	-	Vortice	Vortice	Vortice	Vortice
SFPint	W(m³/s)	690,92	564,90	470,53	771,93
Declared typology	-	NRVU-U**	NRVU-U**	NRVU-U**	NRVU-U**
Type of drive	-	MSD***	MSD***	MSD***	MSD***
Type of heat recovery system HRS	-	None	None	None	None
Nominal NRVU flow rate	m³/s	0,0661	0,0803	0,889	0,1225
Effective electric power input	kW	0,050	0,050	0,050	0,100
Face velocity at design flow rate	m/s	8,471	6,541	5,030	6,9320
Nominal external pressure (Δps, ext)	Pa	19	18	29	16
Internal pressure drop of ventilation components (Δps,int)	Pa	200	175	148	278
Internal pressure drop of non-ventilation components (Δps,add)	Pa	0	0	0	0
Static efficiency of fans used in accordance with Regulation (EU) N. 327/2011	%	29	31	31,5	36,0
Declared maximum internal leakage rate of the casing of ventilation units	%	NA*	NA*	NA*	NA*
Declared maximum external leakage rate of the casing of ventilation units	%	NA*	NA*	NA*	NA*
Energy performance energy or classification of the filters	-	NA*	NA*	NA*	NA*
Description of visual filter warning	-	NA*	NA*	NA*	NA*
Casing sound power level	LWA[dB(A)]	51	51	53	57

\*NA: Not applicable - \*\*RVU-U: Non Residential Ventilation Unit - Unidirectional - \*\*\*MSD: Multi-Speed Drive

	UNIT OF MEASURE	CA-IL160 Q	CA-IL 160	CA-IL 200
<b>CODE</b>		16253	16255	16256
Supplier's name or trade mark	-	Vortice	Vortice	Vortice
SFPint	W(m³/s)	518,36	835,83	569,95
Declared typology	-	NRVU-U**	NRVU-U**	NRVU-U**
Type of drive	-	MSD***	MSD***	MSD***
Type of heat recovery system HRS	-	None	None	None
Nominal NRVU flow rate	m³/s	0,0781	0,1186	0,2183
Effective electric power input	kW	0,050	0,105	0,141
Face velocity at design flow rate	m/s	3,882	5,8992	6,9497
Nominal external pressure (Δps, ext)	Pa	38	17	34
Internal pressure drop of ventilation components (Δps,int)	Pa	161	287	255
Internal pressure drop of non-ventilation components (Δps,add)	Pa	0	0	0
Static efficiency of fans used in accordance with Regulation (EU) N. 327/2011	%	31,1	34,3	44,8
Declared maximum internal leakage rate of the casing of ventilation units	%	NA*	NA*	NA*
Declared maximum external leakage rate of the casing of ventilation units	%	NA*	NA*	NA*
Energy performance energy or classification of the filters	-	NA*	NA*	NA*
Description of visual filter warning	-	NA*	NA*	NA*
Casing sound power level	LWA[dB(A)]	54	57	62

\*NA: Not applicable - \*\*RVU-U: Non Residential Ventilation Unit - Unidirectional - \*\*\*MSD: Multi-Speed Drive





## COMMERCIAL VENTILATION

### CA IN-LINE RANGE

#### SOUNDS LEVELS

Models	Breakout sound power LwA dB(A)			Sound pressure Lp <sub>3m</sub> * dB(A)			Sound power on extract dB(A)			Sound power on supply dB(A)		
	Max Speed	Mid. Speed	Min. Speed	Max Speed	Mid. Speed	Min. Speed	Max Speed	Mid. Speed	Min. Speed	Max Speed	Mid. Speed	Min. Speed
CA-IL 100	51	45	34	30,5	24,5	13,5	60	57	42	64	60	46
CA-IL 125	52	46	35	31,5	25,5	14,5	60	56	42	72	63	52
CA-IL 150 Q	53	48	36	32,5	27,5	15,5	61	54	41	65	58	45
CA-IL 150	57	50	42	36,5	29,5	21,5	67	60	51	70	63	54
CA-IL 160 Q	54	46	38	33,7	25,6	17,4	62	54	41	63	58	44
CA-IL 160	57	50	42	36,5	29,5	21,5	67	57	48	69	60	51
CA-IL 200	62	50	40	41,5	29,5	19,5	71	59	49	78	67	54

\*Calculated in free field conditions at 3 m distance in accordance with EN ISO 3741 standard.





DIMENSIONS

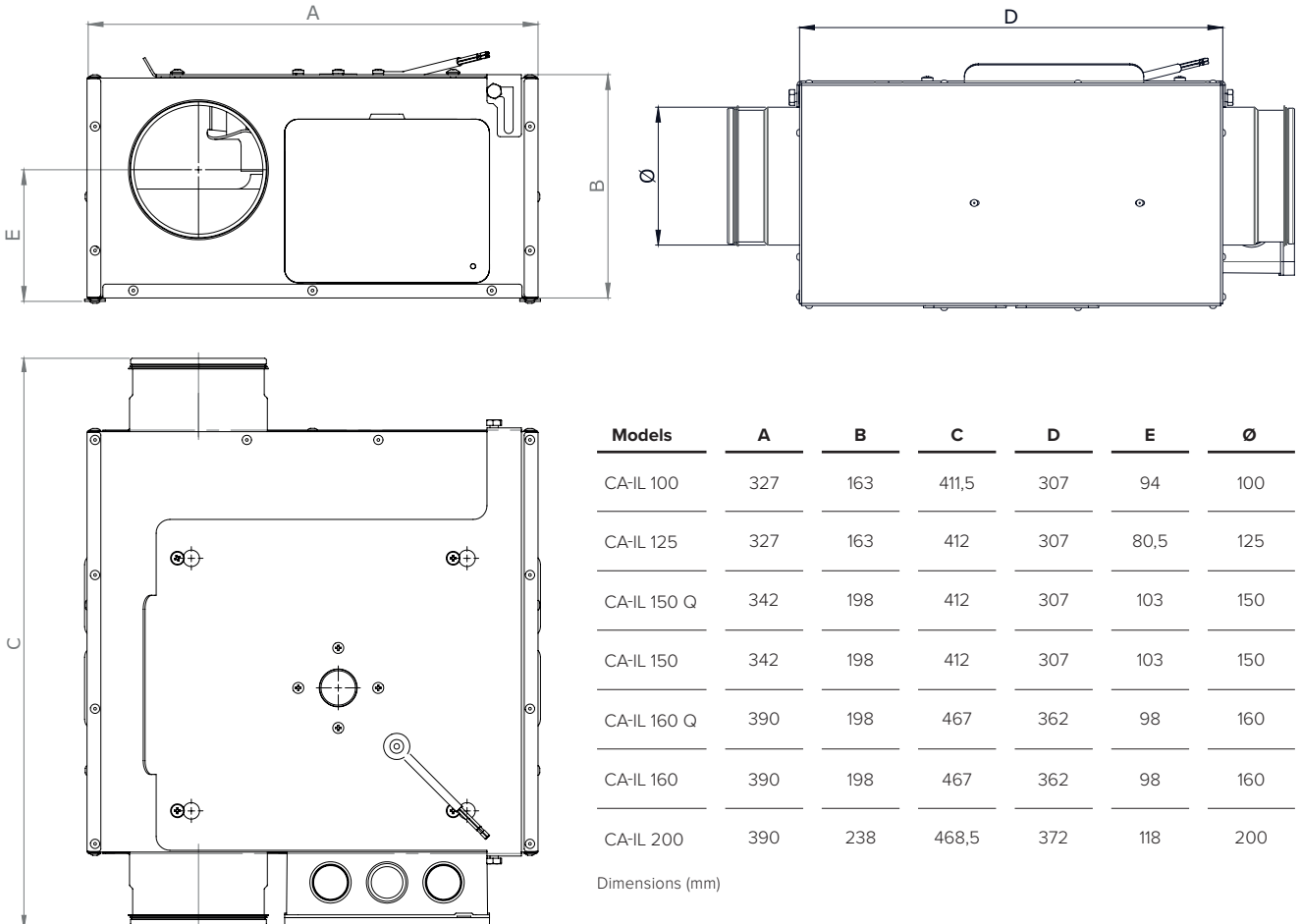

PERFORMANCES CURVES

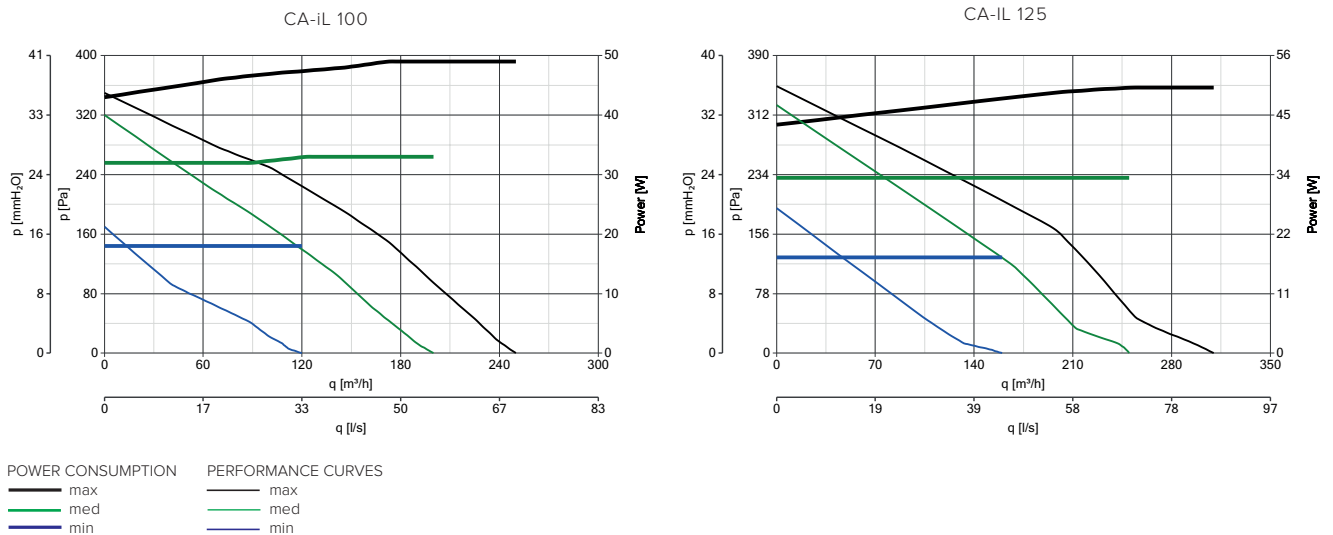



# COMMERCIAL VENTILATION

## CA IN-LINE RANGE

### PERFORMANCES CURVES

CA-IL 150 Q

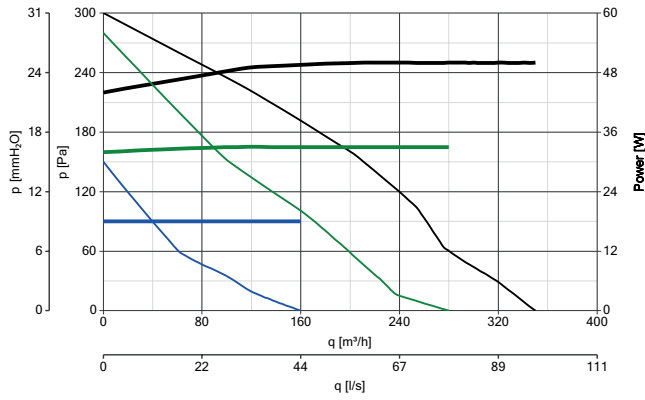

CA-IL 150

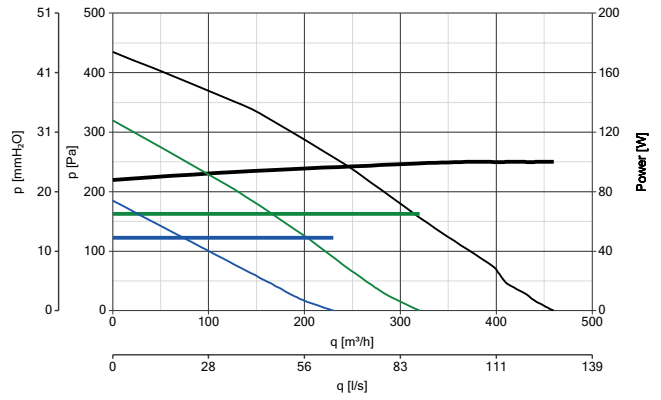

CA-IL 160 Q

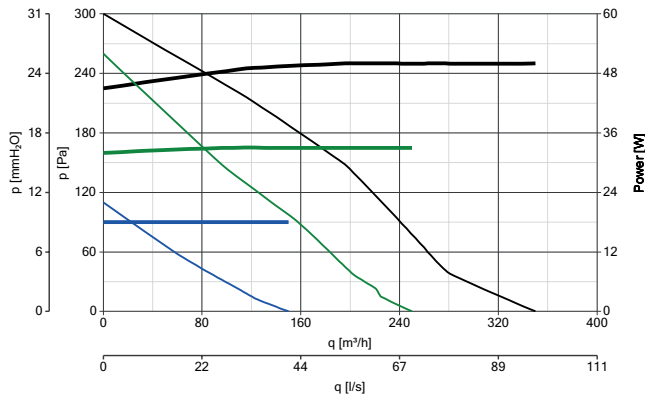

CA-IL 160

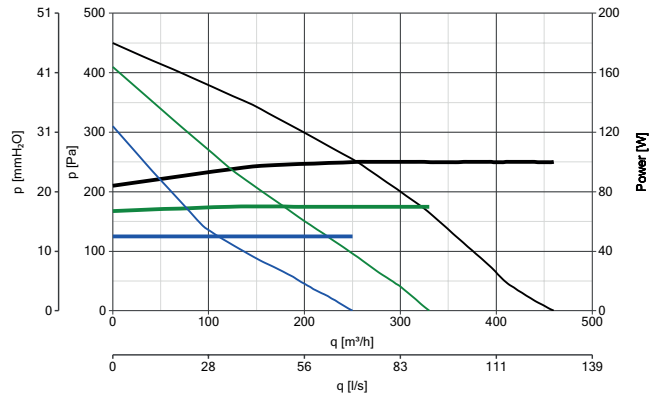



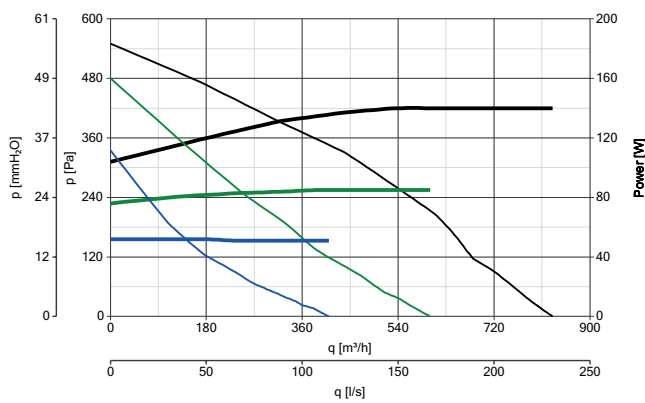



CA-IL 200



POWER CONSUMPTION	PERFORMANCE CURVES
— max	— max
— med	— med
— min	— min



**CONTROLLERS**

MODELS	DESCRIPTION	CODE	PRODUCT
	<b>C 1.5</b> - ELECTRONIC SPEED CONTROLLER 1.5 A	12966	ALL PRODUCTS
	<b>KIT SCB</b> - BUILT-IN CONTROLLER ADAPTOR	22481	12966
	<b>POT-IT</b> - POTENTIOMETER	12826	ALL PRODUCTS
	<b>POT</b> - POTENTIOMETER	12828	ALL PRODUCTS
	<b>TRIO</b> - 3 SPEED SWITCH FOR WALL AND FLUSH MOUNTING INSIDE UNI 503 STANDARD ELECTRIC BOXES	21196	ALL PRODUCTS
	<b>TRIO D</b> - 3 SPEED SWITCH FOR WALL AND FLUSH MOUNTING INSIDE DIN STANDARD ELECTRIC BOXES	12866	ALL PRODUCTS
	<b>IREM D</b> - ELECTRONIC STEPLESS SPEED SWITCH FOR WALL AND FLUSH MOUNTING INSIDE DIN STANDARD ELECTRIC BOX	12867	ALL PRODUCTS

**ACCESSORIES ON REQUEST**

MODELS	DESCRIPTION	CODE	PRODUCT
		100	21177
		125	21178
	<b>GR</b> - PROTECTIVE METAL GRIDS (TO ASSEMBLED ON THE PRODUCT)	150	21179
		160	21180
		200	21181
		100	21182
		125	21183
	<b>FS</b> - FLEXIBLE SLEEVES WITH CLAMPS FOR HOSE FASTENING	150	21184
		160	21185
		200	21186
	<b>TRA 250</b> - OUTLET PORT PROTECTION GRILLES - FITTED TO THE APPLIANCE INTAKE TO PREVENT ACCIDENTAL CONTACT WITH MOVING PARTS IF THE APPLIANCE IS INSTALLED IN AN ACCESSIBLE POSITION	51150	16253 - 16255 - 16256
	<b>PGR 250</b> - PLASTIC MADE GRAVITY SHUTTERS	50150	16253 - 16255 - 16256

## CA IN-LINE QUIET RANGE

Soundproof compact flat in-line centrifugal fans

Suitable for indoor wall-mounted applications at the end of ventilation ducts in residential and industrial environments as factories, hospitals, gyms, restaurants, etc...

### TECHNICAL FEATURES

- Casings made of galvanized steel sheet, robust and resistant to corrosion, highly (IP44) protected against dust and water when ducted; improved inner sound proof lining, consisting of 50 mm thick melamine coating, to dramatically reduce noise emissions into adjacent rooms.
- Fixing brackets, made of galvanized steel sheet, integrated in the casings to speed up installation.
- Circular spigots for connection to standard commercial hoses, fitted with a double lip rubber gasket for perfect air tightness.
- Highly efficient backward curved centrifugal impellers directly coupled to single-phase, 3 speed, protected against overheating, external rotor motors. Ball bearings to grant long lasting (at least 30.000 h) continuous duty at the maximum rated temperature. Speed setting through Vortice speed switches (optional); speed control from 0-100% by means of Vortice's electronic speed controllers (optional).
- Electrical connection boxes, made of plastic resin shock proof and resistant to aggressive agents, with a very high (IP55) protection against dust and water.
- Protection against dust and water: IP44 (when ducted).
- Electric insulation class: I (grounding mandatory).

### TECHNICAL DATA

Models	Code	V 50/60Hz	W*			A max	Max airflow*					Max pressure*					Max* °C	Kg		
			max/med/min				m <sup>3</sup> /h max/med/min	l/s max				mmH <sub>2</sub> O max/med/min	Pa max/med/min							
CA-IL100 QUIET	16260	230	50	33	18	0,22	250	200	120	69	55	33	35,7	32,8	17,7	350	315	170	40	5,6
CA-IL125 QUIET	16261	230	50	33	18	0,22	310	250	160	86,1	69	44	35,7	33,8	19,7	350	325	190	40	5,6
CA-IL150 Q QUIET	16262	230	50	33	18	0,23	350	280	160	97,2	97	44	30,6	29,1	15,1	300	280	145	40	6
CA-IL150 QUIET	16264	230	100	65	49	0,44	460	320	230	128	89	64	44,1	33,3	19,2	435	320	185	40	6
CA-IL160 Q QUIET	16263	230	50	33	18	0,23	350	250	160	97	64	69	30,6	27	22,9	300	260	220	40	6,2
CA-IL160 QUIET	16265	230	100	70	50	0,46	460	330	250	128	92	69	45,9	42,7	32,2	450	410	310	40	6,2
CA-IL200 QUIET	16266	230	140	85	50	0,61	830	600	410	231	167	114	55,3	50	3,8	550	480	335	40	9,6

\* Values referred to 230V/50Hz



ENERGY DATA FOR REGULATION N° 1254/2014/UE

CODE	UNIT OF MEASURE	CA-IL 100 QUIET	CA-IL 125 QUIET	CA-IL 150 Q QUIET	CA-IL 150 QUIET
Supplier's name or trade mark	-	Vortice	Vortice	Vortice	Vortice
SFPint	W(m³/s)	690,92	564,90	470,53	771,93
Declared typology	-	NRVU-U**	NRVU-U**	NRVU-U**	NRVU-U**
Type of drive	-	MSD***	MSD***	MSD***	MSD***
Type of heat recovery system HRS	-	None	None	None	None
Nominal NRVU flow rate	m³/s	0,0661	0,0803	0,0889	0,1225
Effective electric power input	kW	0,050	0,050	0,050	0,100
Face velocity at design flow rate	m/s	8,417	6,541	5,030	6,9320
Nominal external pressure (Δps, ext)	Pa	19	18	29	16
Internal pressure drop of ventilation components (Δps,int)	Pa	200	175	148	278
Internal pressure drop of non-ventilation components (Δps,add)	Pa	0	0	0	0
Static efficiency of fans used in accordance with Regulation (EU) N. 327/2011	%	29	31	31,5	36,0
Declared maximum internal leakage rate of the casing of ventilation units	%	NA*	NA*	NA*	NA*
Declared maximum external leakage rate of the casing of ventilation units	%	NA*	NA*	NA*	NA*
Energy performance energy or classification of the filters	-	NA*	NA*	NA*	NA*
Description of visual filter warning	-	NA*	NA*	NA*	NA*
Casing sound power level	LWA[dB(A)]	51	51	51	55

\*NA: Not applicable - \*\*RVU-U: Non Residential Ventilation Unit - Unidirectional - \*\*\*MSD: Multi-Speed Drive

CODE	UNIT OF MEASURE	CA-IL160 Q QUIET	CA-IL 160 QUIET	CA-IL 200 QUIET
Supplier's name or trade mark	-	Vortice	Vortice	Vortice
SFPint	W(m³/s)	518,36	835,83	569,95
Declared typology	-	NRVU-U**	NRVU-U**	NRVU-U**
Type of drive	-	MSD***	MSD***	MSD***
Type of heat recovery system HRS	-	None	None	None
Nominal NRVU flow rate	m³/s	0,0781	0,1186	0,2183
Effective electric power input	kW	0,050	0,105	0,141
Face velocity at design flow rate	m/s	3,882	5,8992	6,9497
Nominal external pressure (Δps, ext)	Pa	38	17	34
Internal pressure drop of ventilation components (Δps,int)	Pa	161	287	255
Internal pressure drop of non-ventilation components (Δps,add)	Pa	0	0	0
Static efficiency of fans used in accordance with Regulation (EU) N. 327/2011	%	31,1	34,3	44,8
Declared maximum internal leakage rate of the casing of ventilation units	%	NA*	NA*	NA*
Declared maximum external leakage rate of the casing of ventilation units	%	NA*	NA*	NA*
Energy performance energy or classification of the filters	-	NA*	NA*	NA*
Description of visual filter warning	-	NA*	NA*	NA*
Casing sound power level	LWA[dB(A)]	49	55	59

\*NA: Not applicable - \*\*RVU-U: Non Residential Ventilation Unit - Unidirectional - \*\*\*MSD: Multi-Speed Drive





## COMMERCIAL VENTILATION

### CA IN-LINE QUIET RANGE

#### SOUNDS LEVELS

Models	Breakout sound power LwA dB(A)			Sound pressure Lp <sub>3m</sub> * dB(A)			Sound power on extract dB(A)			Sound power on supply dB(A)		
	Max Speed	Mid. Speed	Min. Speed	Max Speed	Mid. Speed	Min. Speed	Max Speed	Mid. Speed	Min. Speed	Max Speed	Mid. Speed	Min. Speed
CA-IL 100 QUIET	51	44	30	30,5	23,5	9,5	52	47	34	63	59	44
CA-IL 125 QUIET	51	44	34	30,5	23,5	13,5	52	49	34	64	60	45
CA-150 Q QUIET	51	44	33	30,5	23,5	12,5	53	45	32	64	57	44
CA-IL 150 QUIET	55	47	40	34,5	26,5	19,5	63	50	42	71	59	51
CA-IL 160 Q QUIET	49	44	33	28,5	23,5	12,5	51	46	33	64	58	44
CA-IL 160 QUIET	55	47	40	34,5	26,5	19,5	60	48	40	68	58	49
CA-IL 200 QUIET	59	50	37	38,5	29,5	16,5	66	53	44	76	65	54

\*Calculated in free field conditions at 3 m distance in accordance with EN ISO 3741 standard.





DIMENSIONS

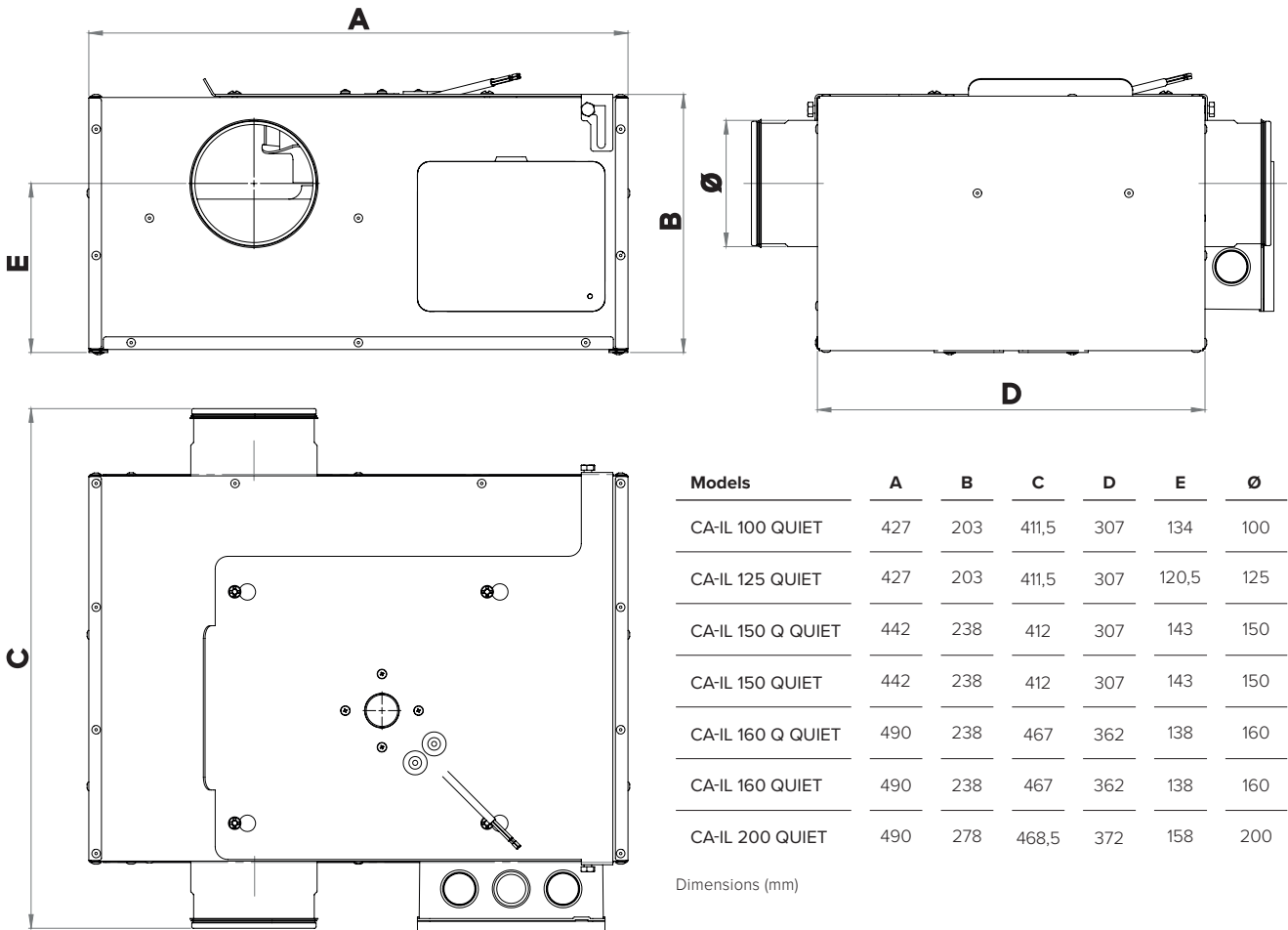

PERFORMANCES CURVES

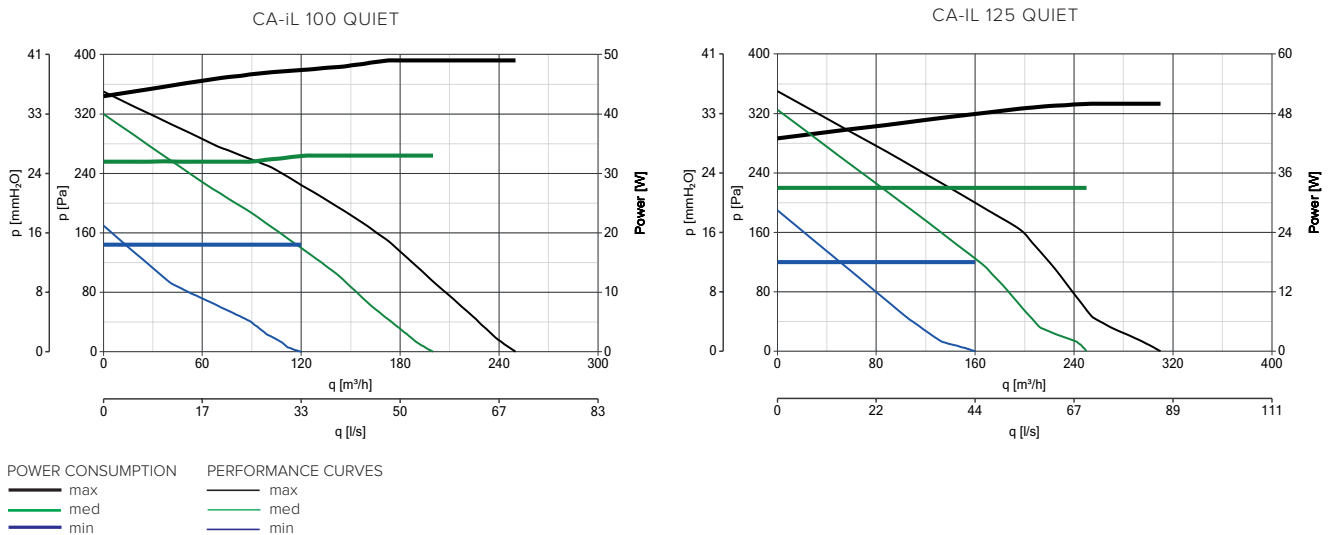



# COMMERCIAL VENTILATION

## CA IN-LINE QUIET RANGE

### PERFORMANCES CURVES

CA-IL 150 Q QUIET

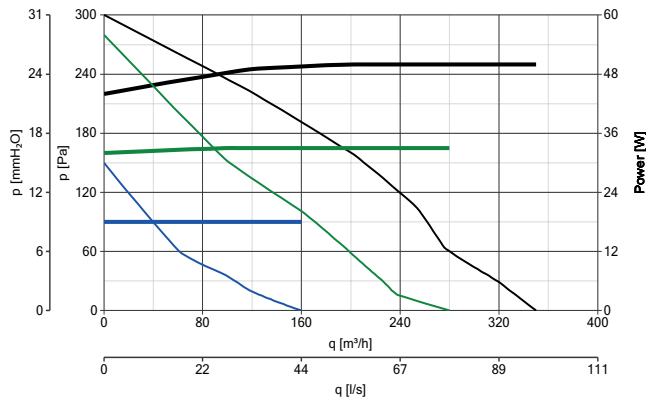

CA-IL 150 QUIET

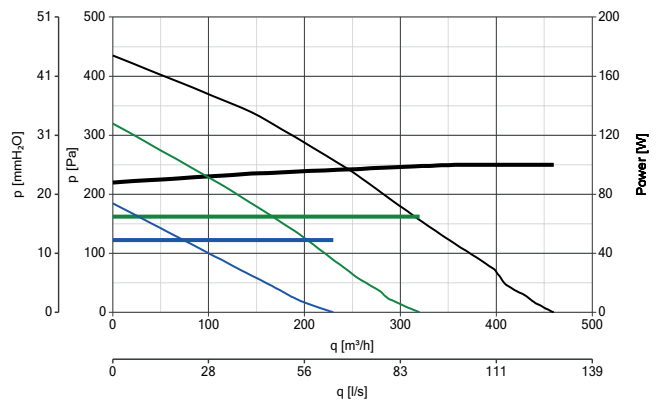

CA-IL 160 Q QUIET

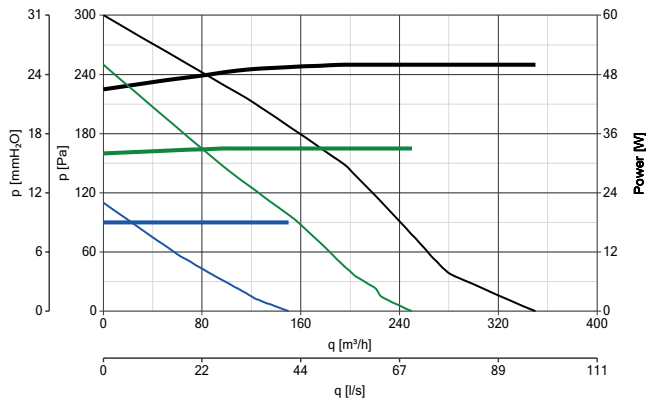

CA-IL 160 QUIET

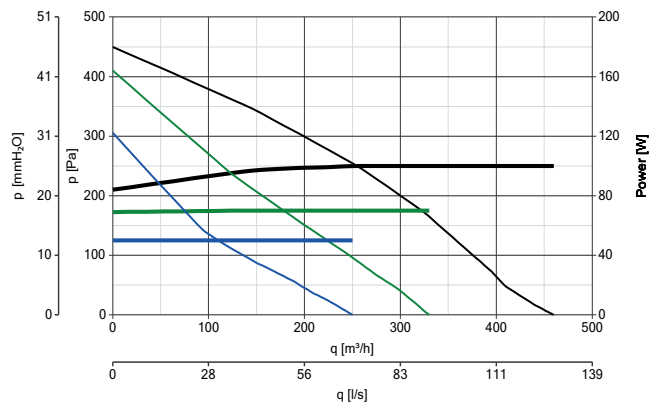



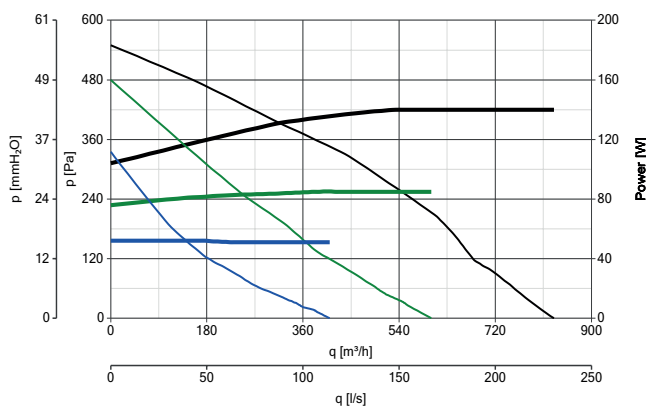



CA-IL 200



POWER CONSUMPTION	PERFORMANCE CURVES
— max	— max
— med	— med
— min	— min



**CONTROLLERS**

MODELS	DESCRIPTION	CODE	PRODUCT
	<b>C 1.5</b> - ELECTRONIC SPEED CONTROLLER 1.5 A	12966	ALL PRODUCTS
	<b>KIT SCB</b> - BUILT-IN CONTROLLER ADAPTOR	22481	12966
	<b>POT-IT</b> - POTENTIOMETER	12826	ALL PRODUCTS
	<b>POT</b> - POTENTIOMETER	12828	ALL PRODUCTS
	<b>TRIO</b> - 3 SPEED SWITCH FOR WALL AND FLUSH MOUNTING INSIDE UNI 503 STANDARD ELECTRIC BOXES	21196	ALL PRODUCTS
	<b>TRIO D</b> - 3 SPEED SWITCH FOR WALL AND FLUSH MOUNTING INSIDE DIN STANDARD ELECTRIC BOXES	12866	ALL PRODUCTS
	<b>IREM D</b> - ELECTRONIC STEPLESS SPEED SWITCH FOR WALL AND FLUSH MOUNTING INSIDE DIN STANDARD ELECTRIC BOX	12867	ALL PRODUCTS

**ACCESSORIES ON REQUEST**

MODELS	DESCRIPTION	CODE	PRODUCT
		100	21177 16250
		125	21178 16251
	<b>GR</b> - PROTECTIVE METAL GRIDS (TO ASSEMBLED ON THE PRODUCT)	150	21179 16252 - 16254
		160	21180 16253 - 16255
		200	21181 16256
		100	21182 16250
		125	21182 16251
	<b>FS</b> - FLEXIBLE SLEEVES WITH CLAMPS FOR HOSE FASTENING	150	21183 16252 - 16254
		160	21185 16253 - 16255
		200	21186 16256
	<b>TRA 250</b> - OUTLET PORT PROTECTION GRILLES - FITTED TO THE APPLIANCE INTAKE TO PREVENT ACCIDENTAL CONTACT WITH MOVING PARTS IF THE APPLIANCE IS INSTALLED IN AN ACCESSIBLE POSITION	51150	16265 - 16266
	<b>PGR 250</b> - PLASTIC MADE GRAVITY SHUTTERS	50150	16265 - 16266

## CA IN-LINE QUIET ES RANGE

Soundproof compact flat in-line centrifugal EC fans

Suitable for indoor wall-mounted applications at the end of ventilation ducts in residential and industrial environments as factories, hospitals, gyms, restaurants, etc...

### TECHNICAL FEATURES

- Casings made of galvanized steel sheet, robust and resistant to corrosion, highly (IP44) protected against dust and water when ducted; improved inner sound proof lining, consisting of 50 mm thick melamine coating, to dramatically reduce noise emissions into adjacent rooms.
- Fixing brackets, made of galvanized steel sheet, integrated in the casings to speed up installation.
- Circular spigots for connection to standard commercial hoses, fitted with a double lip rubber gasket for perfect air tightness.
- Highly efficient backward curved centrifugal impellers directly coupled with energy saving, speed controllable (0-10 V signal) single-phase, EC (brushless), protected against overheating, external rotor motors. Ball bearings to grant long lasting (at least 40.000 h) continuous duty at the maximum rated temperature. Speed setting through Vortice potentiometers (optional).
- Electrical connection boxes, made of plastic resin shock proof and resistant to aggressive agents, with a very high (IP55) protection against dust and water.
- Protection against dust and water: IP44 (when ducted)
- Electric insulation class: I (grounding mandatory).

### TECHNICAL DATA

Models	Code	V 50/60Hz	W*	A	Max airflow*		Max pressure*		Max* °C	Kg
					m <sup>3</sup> /h max	l/s max	mmH <sub>2</sub> O max	Pa max		
CA-IL100 QUIET ES	16270	220/240	85	0,73	310	86,1	71,4	700	40	5,6
CA-IL125 QUIET ES	16271	220/240	85	0,74	380	105,5	72,4	710	40	5,6
CA-IL150 QUIET ES	16274	220/240	85	0,73	450	125	63,2	620	40	6
CA-IL160 QUIET ES	16275	220/240	85	0,74	480	133,3	61,1	600	40	6
CA-IL200 QUIET ES	16276	220/240	110	0,91	850	236,1	56	550	40	6,2

\* Values referred to 230V/50Hz



ENERGY DATA FOR REGULATION N° 1254/2014/UE

	UNIT OF MEASURE	CA-IL 100 QUIET ES	CA-IL 125 QUIET ES	CA-IL 150 QUIET ES	CA-IL 160 QUIET ES	CA-IL 200 QUIET ES
CODE		16270	16271	16274	16275	16276
Supplier's name or trade mark	-	Vortice	Vortice	Vortice	Vortice	Vortice
SFPint	W(m³/s)	1002,42	770,82	644,12	585,45	413,18
Declared typology	-	NRVU-U**	NRVU-U**	NRVU-U**	NR-VU-U**	NR-VU-U**
Type of drive	-	MSD***	MSD***	MSD***	MSD***	MSD***
Type of heat recovery system HRS	-	None	None	None	None	None
Nominal NRVU flow rate	m³/s	0,0794	0,0883	0,1150	0,1197	0,2208
Effective electric power input	kW	0,085	0,085	0,085	0,085	0,109
Face velocity at design flow rate	m/s	10,115	7,1980	6,5076	5,9545	413,18
Nominal external pressure (Δps, ext)	Pa	26	78	41	52	36
Internal pressure drop of ventilation components (Δps,int)	Pa	386	314	278	262	185
Internal pressure drop of non-ventilation components (Δps,add)	Pa	0	0	0	0	
Static efficiency of fans used in accordance with Regulation (EU) N. 327/2011	%	38,5	40,7	43,2	44,8	44,8
Declared maximum internal leakage rate of the casing of ventilation units	%	NA*	NA*	NA*	NA*	NA*
Declared maximum external leakage rate of the casing of ventilation units	%	NA*	NA*	NA*	NA*	NA*
Energy performance energy or classification of the filters	-	NA*	NA*	NA*	NA*	NA*
Description of visual filter warning	-	NA*	NA*	NA*	NA*	NA*
Casing sound power level	LWA[dB(A)]	59	59	56	56	58

\*NA: Not applicable - \*\*RVU-U: Non Residential Ventilation Unit - Unidirectional - \*\*\*MSD: Multi-Speed Drive

SOUNDS LEVELS

Models	Breakout sound power LwA dB(A)			Sound pressure Lp <sub>3m</sub> * dB(A)			Sound power on extract dB(A)			Sound power on supply dB(A)		
	Max Speed	Mid Speed	Min Speed	Max Speed	Mid Speed	Min Speed	Max Speed	Mid Speed	Min Speed	Max Speed	Mid Speed	Min Speed
CA-IL 100 QUIET ES	60	47	36	39,5	26,5	15,5	61	52	42	72	63	53
CA-IL 125 QUIET ES	59	47	37	38,5	26,5	16,5	62	51	41	71	61	52
CA-IL-150 QUIET ES	56	47	41	35,5	26,5	20,5	60	53	47	71	64	57
CA-IL 160 QUIET ES	56	47	41	35,5	26,5	20,5	58	48	40	68	60	51
CA-IL 200 QUIET ES	58	53	43	37,5	32,5	22,5	63	55	46	74	67	56

\*Calculated in free field conditions at 3 m distance in accordance with EN ISO 374 standard.

DIMENSIONS

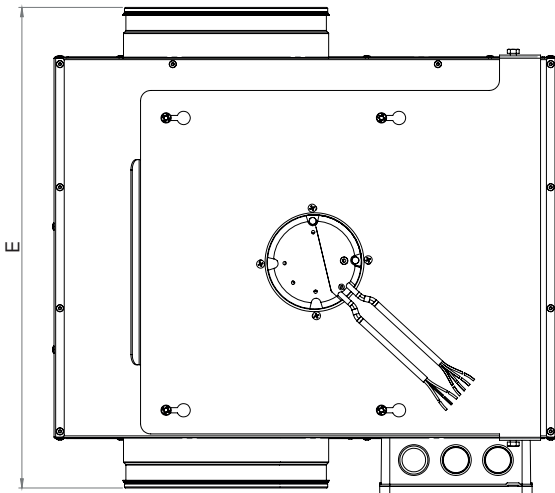
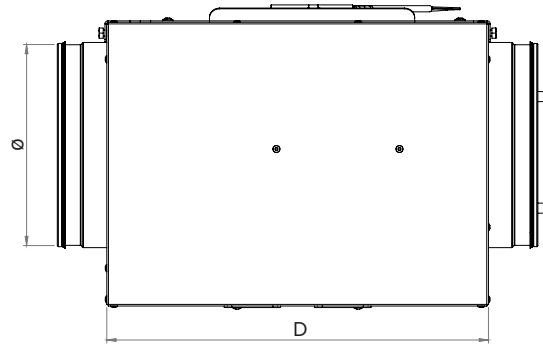
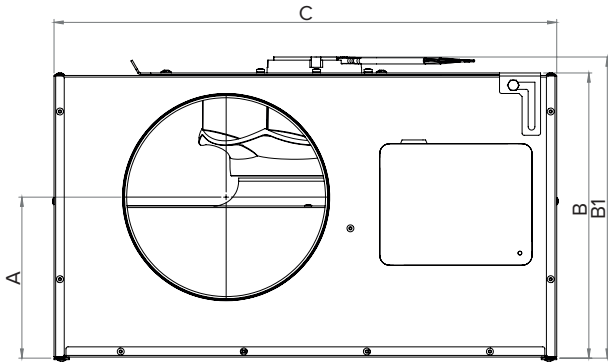

Models	A	B	B1	C	D	E	Ø
CA-IL 100 QUIET ES	134	203	203	427	307	411,5	100
CA-IL 125 QUIET ES	120,5	203	203	427	307	411,5	125
CA-IL 150 QUIET ES	143	238	203	442	307	412	150
CA-IL 160 QUIET ES	138	238	203	490	362	467	160
CA-IL 200 QUIET ES	163	277	288,5	490	372	468,5	200

Dimensions (mm)

PERFORMANCES CURVES

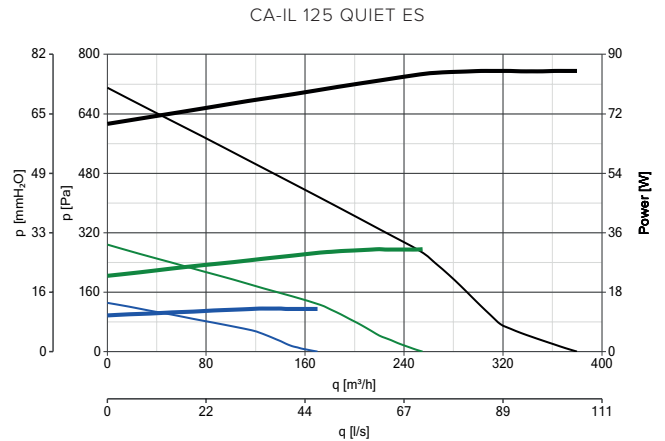
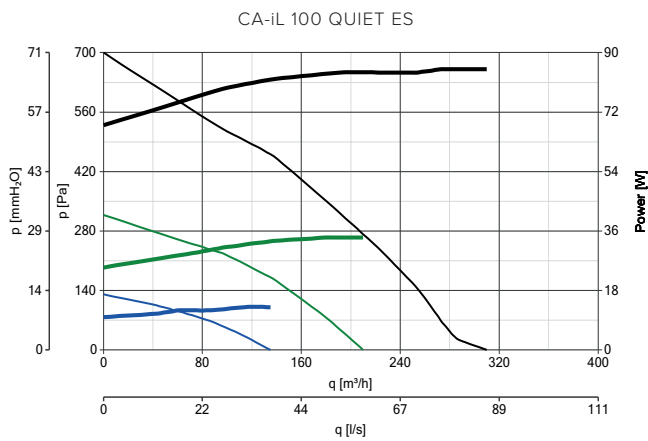

POWER CONSUMPTION  
 — max  
 — med  
 — min

PERFORMANCE CURVES  
 — max  
 — med  
 — min



PERFORMANCES CURVES

CA-IL 150 QUIET ES

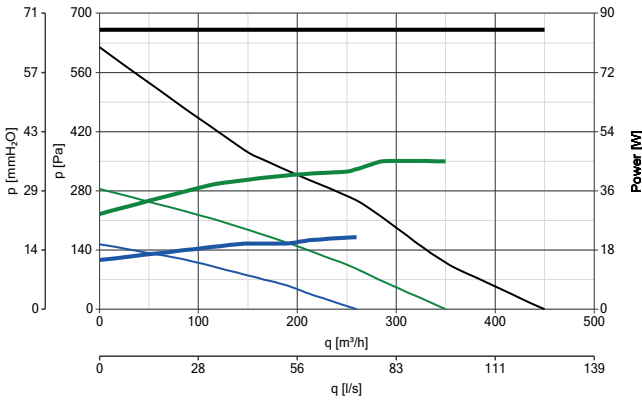

CA-IL 160 QUIET ES

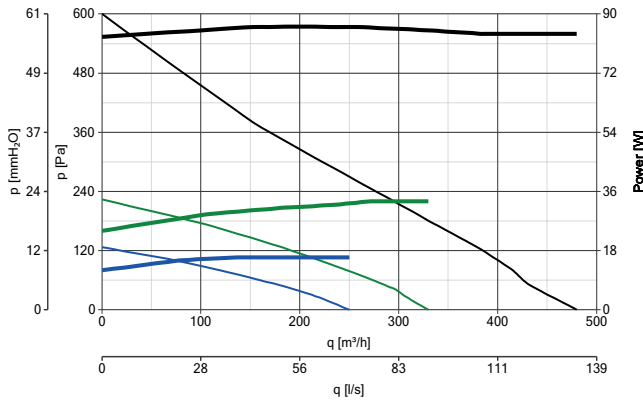

CA-IL 200 QUIET ES

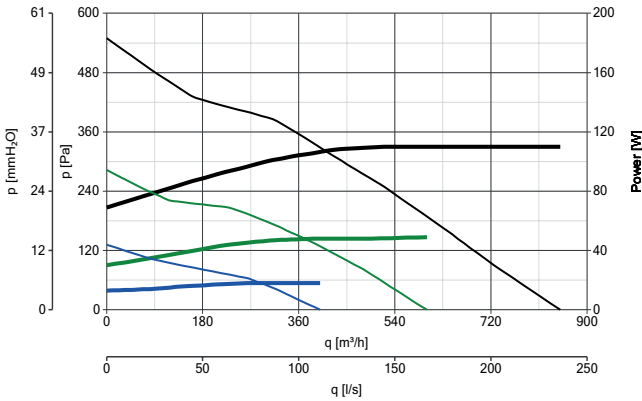

POWER CONSUMPTION      PERFORMANCE CURVES  
— max                              — max  
— med                              — med  
— min                              — min





## COMMERCIAL VENTILATION

### CA IN-LINE QUIET RANGE ES

#### CONTROLLERS

MODELS	DESCRIPTION	CODE	PRODUCT
	<b>C 1.5</b> - ELECTRONIC SPEED CONTROLLER 1.5 A	12966	ALL PRODUCTS
	<b>KIT SCB</b> - BUILT-IN CONTROLLER ADAPTOR	22481	12966
	<b>POT-IT</b> - POTENTIOMETER	12826	ALL PRODUCTS
	<b>POT</b> - POTENTIOMETER	12828	ALL PRODUCTS
	<b>TRIO</b> - 3 SPEED SWITCH FOR WALL AND FLUSH MOUNTING INSIDE UNI 503 STANDARD ELECTRIC BOXES	21196	ALL PRODUCTS
	<b>TRIO D</b> - 3 SPEED SWITCH FOR WALL AND FLUSH MOUNTING INSIDE DIN STANDARD ELECTRIC BOXES	12866	ALL PRODUCTS
	<b>IREM D</b> - ELECTRONIC STEPLESS SPEED SWITCH FOR WALL AND FLUSH MOUNTING INSIDE DIN STANDARD ELECTRIC BOX	12867	ALL PRODUCTS

#### ACCESSORIES ON REQUEST

MODELS	DESCRIPTION	CODE	PRODUCT
		100	21177 16270
		125	21178 16271
	<b>GR</b> - PROTECTIVE METAL GRIDS (TO ASSEMBLED ON THE PRODUCT)	150	21179 16274
		160	21180 16275
		200	21181 16276
		100	21182 16270
		125	21183 16271
	<b>FS</b> - FLEXIBLE SLEEVES WITH CLAMPS FOR HOSE FASTENING	150	21184 16274
		160	21185 16275
		200	21186 16276
	<b>TRA 250</b> - OUTLET PORT PROTECTION GRILLES - FITTED TO THE APPLIANCE INTAKE TO PREVENT ACCIDENTAL CONTACT WITH MOVING PARTS IF THE APPLIANCE IS INSTALLED IN AN ACCESSIBLE POSITION	51150	16275 - 16276
	<b>PGR 250</b> - PLASTIC MADE GRAVITY SHUTTERS	50150	16275 - 16276







Vortice Elettrosociali S.p.A  
Strada Cerca, 2  
Frazione di Zoate  
20067 Tribiano (Milano)  
Tel. (+39) 02 906991  
Fax (+39) 02 90699625  
Italia  
[www.vortice.com](http://www.vortice.com)

Vortice Limited  
Beeches House-Eastern  
Avenue Burton on Trent  
DE13 0BB  
Tel. (+44) 1283-49.29.49  
Fax (+44) 1283-54.41.21  
United Kingdom  
[www.vortice.ltd.uk](http://www.vortice.ltd.uk)

Vortice Ventilation System  
(ChangZhou) Co.LTD  
No. 388 West Huanghe Road  
Building 19, ChangXhou  
Post Code: 213000  
China  
Tel. (+86) 0519 88990150  
Fax (+86) 0519 88990151  
[www.vortice-china.com](http://www.vortice-china.com)

Vortice Latam S.A.  
3er Piso, Oficina 9-B  
Edificio Meridiano  
Guachipelín, Escazú  
San José, Costa Rica  
PO Box 10-1251  
Tel. (+506) 2201.6219  
Fax (+506) 2201.6239  
[www.vortice-latam.com](http://www.vortice-latam.com)

