

2026-  
TOTAL  
PRODUCTS  
CATALOG

**KDS**  
MURATEC-KDS CORP.

**MURATEC-KDS CORP.**

**MURATEC-KDS CORPORATION HEAD OFFICE**  
3, Minamiochiai-cho, Kisshoin, Minami-ku,  
Kyoto, 601-8326 JAPAN  
TEL. +81-75-681-2761 FAX. +81-75-661-2764  
E-mail : [mailto@muratec-kds.jp](mailto:mailto@muratec-kds.jp)

**Chicago correspondent**  
TEL. +1-503-329-3107  
Email: [kevin.carter.kds@muratec-usa.com](mailto:kevin.carter.kds@muratec-usa.com)

**KDS Manufacturing (M) Sdn Bhd**  
Lot 7963, Batu 22, Jalan Air Hitam,  
81000 Kulai, Johor, Malaysia  
E-mail: [sales@kds-ml.com.my](mailto:sales@kds-ml.com.my)

<https://muratec-kds.jp/en/>





**C**ustomer service & Delivery service

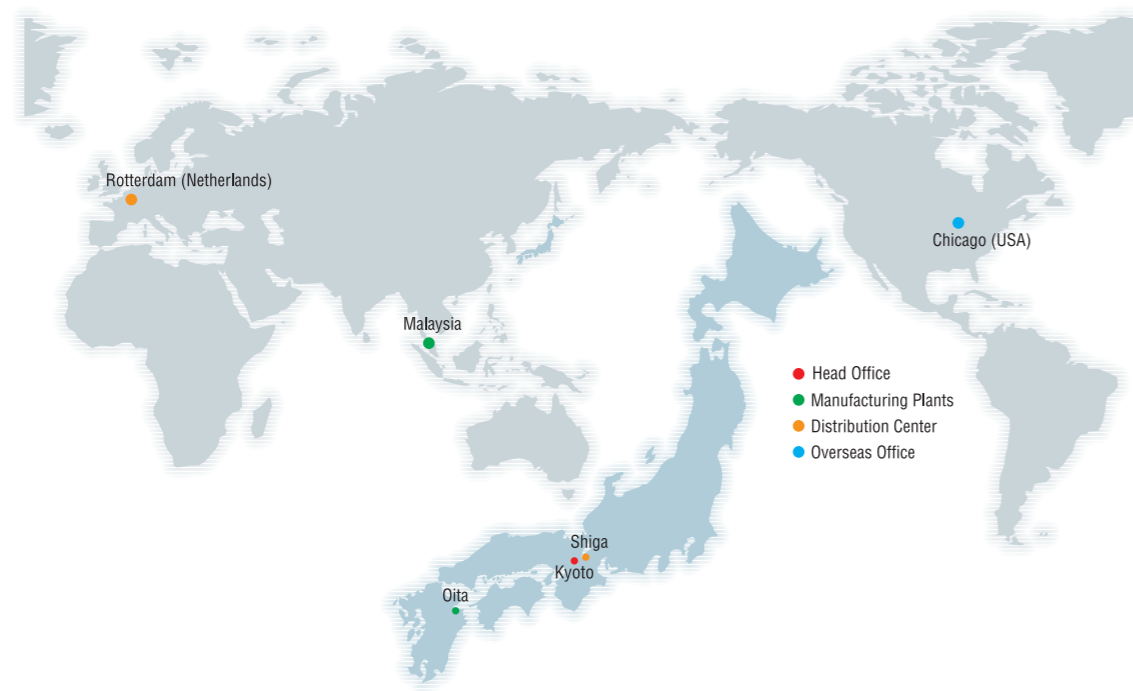

**MURATEC-KDS CORP.**  
The design and calibration service of steel tape measures, textile tape measures.  
The design, manufacture and servicing of cutter knives, digital pole measures, weight and height digital scales.  
Servicing of builder's and surveyor's equipment.



**KDS MANUFACTURING (M) SDN BHD**  
Manufacturing and assembly of measuring tape.  
Assembly of anchor line and cutter

# Display Stands

**B-type Stand** ▶  
10 pcs of hook

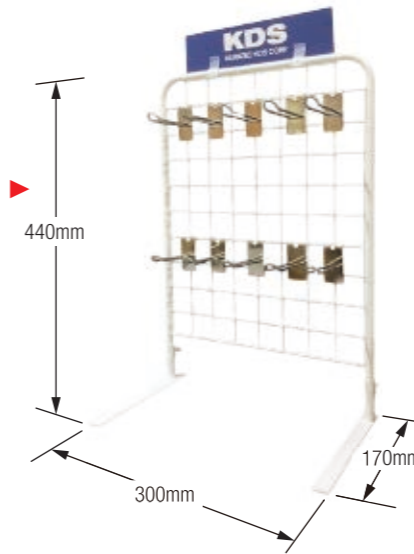

**Revolving Stand** ▶  
30pcs of hook

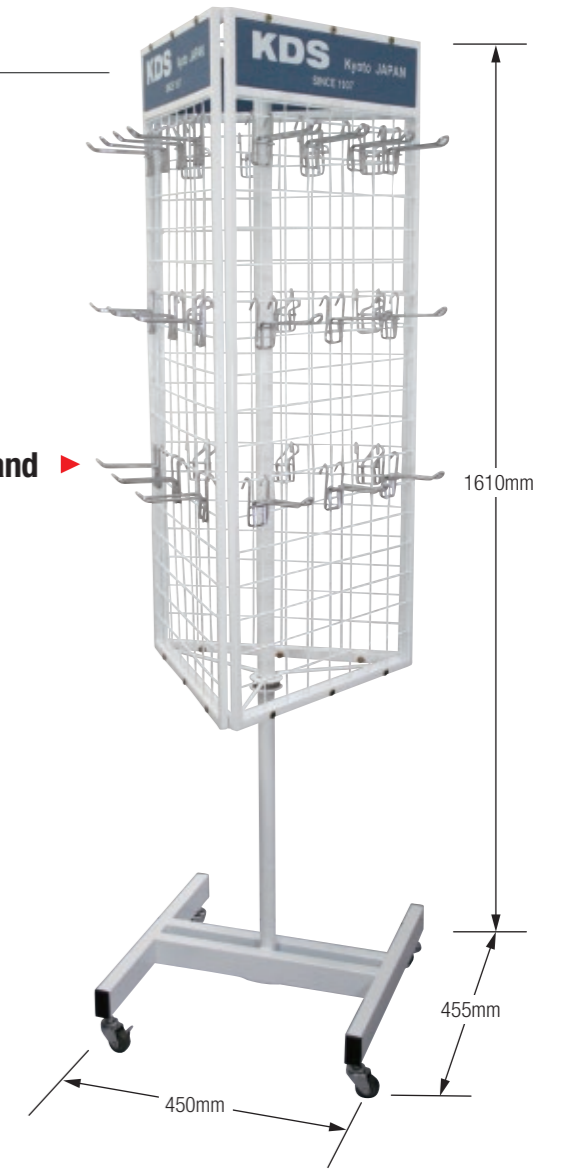

## ■ "All for your finest work."

Corporate Slogan:

In today's workplace, where high-precision tools are indispensable, we will continue to pursue quality and convenience that is chosen by professionals. Heeding the voices in the field to create the next new advantage, we will strive to be a company that expands the possibilities of professional work.



### Summary

Company name	MURATEC-KDS CORP.
President and C.E.O	Yutaka Moriwaki
Head Office	3, Minamiochiai-cho, Kisshoin, Minami-ku, Kyoto, 601-8326 JAPAN
Date of Establishment	1937
Capitalization	100 million yen
No. of employees	150
Sales office	Niigata, Tokyo, Nagoya, Kyoto, Hyogo and Fukuoka
Manufacturing factories	Oita (JAPAN), KDS Malaysia (MALAYSIA)
Distribution Center	Shiga, Rotterdam,
Overseas Office	Chicago (USA)
Co-operated overseas manufactures	STABILA (GERMANY) SUNSHINE MAKERS (USA)

# INDEX

Products line up

**Cutters** 05 ~ 30

**Spare Blades** 31 ~ 44

**Safety-Bases** 45

**Scrapers** 46 ~ 47

**Other Tools** 48 ~ 49

**Pocket Tapes** 50 ~ 59

**Long Tapes** 60 ~ 64

**Electronic Products** 65 ~ 66

**Wooden Chisels / Planers** 67



# Cutters

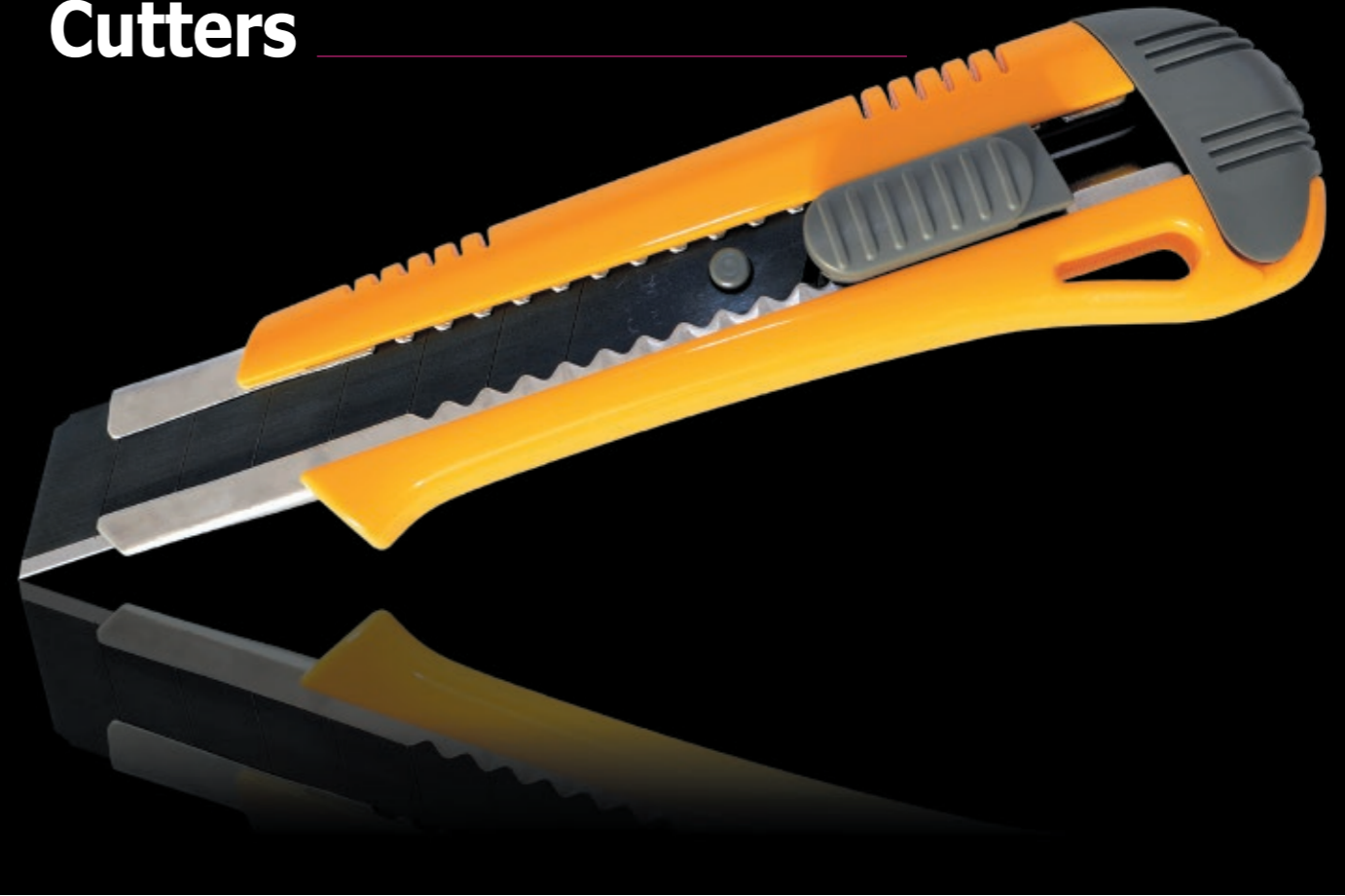

**Feel the difference ! KDS cutters are unique !**

## 1. EXTRA BLADES INCLUDED

Use up your blade on the job ?  
Just open the end cap and pull out a spare blade!

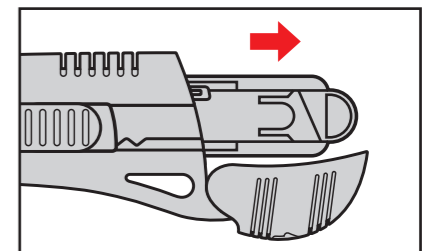
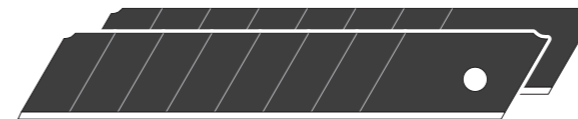

## 2. CHOOSE YOUR LOCK

Select the lock that you prefer : Auto-lock, Screw lock, or Safety lock.  
All locks hold the blade securely.

### Auto-Lock

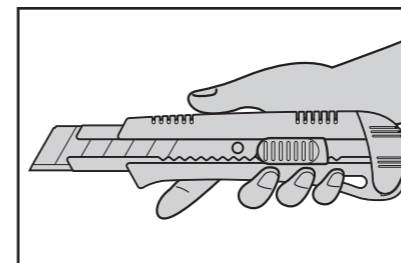



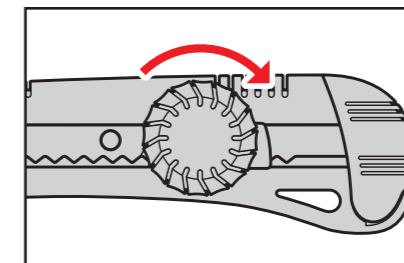

### Screw Lock

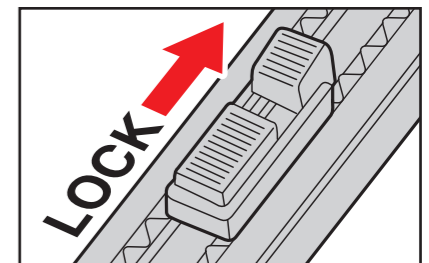

### Safety Lock

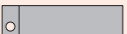

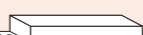
 × 3 (1+2) : Come with 3 blade(s)
  : Blister Packed
  : Plastic Bag
  : With Power Black Evolution Blade(s)
  : Paper Box

## Cutters

### SA-15 Safety Master-G



**NEW**

**EVO**  
Power White Evolution



Plastic-free paper box



Safety lock prevents blade from accidentally popping out.

The SA-15 goes beyond the features of a typical safety knife. Unlike short-blade safety knives, the SA-15 can make deep cuts with the long, solid, thick blade, yet it still automatically retracts to protect against dangerous injuries. Safely cut at various depths with confidence using the KDS SA-15 safety knife.

Cat.No.	Handle color	Suitable blade	QTY/ Inner carton	QTY/ Outer carton	N.W. (kgs)	G.W. (kgs)	M3	Carton size (Cm) D x W x H	EAN
SA-15	Yellow	GB-10NL EVO	10	80	10.3	12.3	0.080	35 x 76.5 x 30	4954183 565497

## Non-Snap G-Blades

**EVO** **DURABLE EDGE**

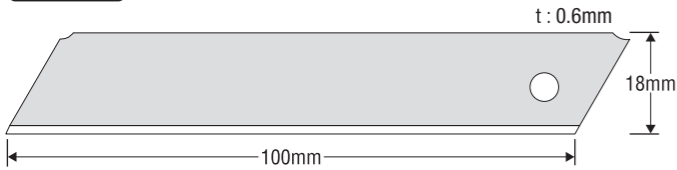

GB-10NL EVO

A thick, non-snap blade that resists fracture when flexing or scraping.

Cat.No.	Number of blades in a case	QTY/ Inner carton	QTY/ Outer carton	N.W. (kgs)	G.W. (kgs)	M3	Carton size (Cm) D x W x H	EAN
GB-10NL EVO	10	20	200	19	21	0.014	24 x 35 x 15.5	4954183 565640

## Cutters Package-Deals

### LC-405 5H



**EVO**  
Power White Evolution

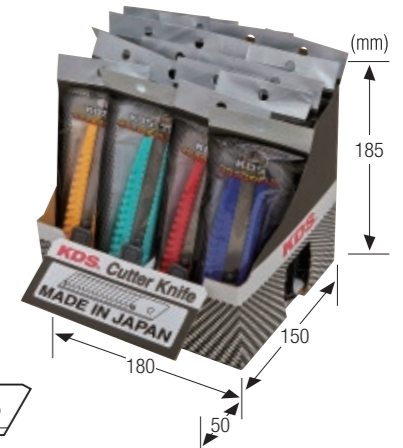

"Safety-Lock" 4 colors assorted. Supplied with 1 piece of 15 segments spare blade.

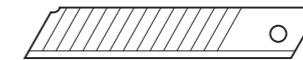

Cat.No.	Handle color	Suitable blade	QTY/ Inner carton	QTY/ Outer carton	N.W. (kgs)	G.W. (kgs)	M3	Carton size (Cm) D x W x H	EAN
LC-405 5H	Blue, Green, Yellow and Red (each 5 pcs. Per set)	LB-10W EVO	20	80	8	10	0.026	32 x 38.3 x 21.2	4954183 527501

### L-18 5H



**EVO**  
Power White Evolution



"Auto-Lock" 4 colors assorted. Supplied with 1 piece of 15 segments blade. Without spare blade and spare blade holder.

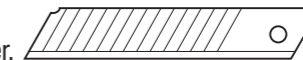

Cat.No.	Handle color	Suitable blade	QTY/ Inner carton	QTY/ Outer carton	N.W. (kgs)	G.W. (kgs)	M3	Carton size (Cm) D x W x H	EAN
L-18 5H	Blue, Green, Yellow and Red (each 5 pcs. Per set)	LB-10W EVO	20	80	7	9	0.026	32 x 38.3 x 21.2	4954183 527495

### L-19 5H



**EVO**  
Power White Evolution



"Twist-Lock" 4 colors assorted. Supplied with 1 piece of 15 segments blade. Without spare blade and spare blade holder.

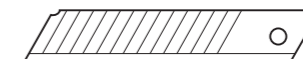

Cat.No.	Handle color	Suitable blade	QTY/ Inner carton	QTY/ Outer carton	N.W. (kgs)	G.W. (kgs)	M3	Carton size (Cm) D x W x H	EAN
L-19 5H	Blue, Green, Yellow and Red (each 5 pcs. Per set)	LB-10W EVO	20	80	7	9	0.026	32 x 38.3 x 21.2	4954183 527488

## Package-Deals

### H-12YE-3B Job Boss Pro Value pack



18 knives in a display box

Extra-heavy-duty cutter with strong ABS plastic body. Screw type slider securely locks the blade in place.

**3 Bonus blades in a storage case.**

Cat.No.	Handle color	Suitable blade	QTY/ Inner carton	QTY/ Outer carton	N.W. (kgs)	G.W. (kgs)	M3	Carton size (Cm) D x W x H	EAN
H-12YE-3B	Yellow	HB-10B EVO	18	18	5	7	0.031	25.5 x 42 x 28.5	4954183 511500

## Cutters

**25 mm**

### Extra Heavy Duty blades

H-blades are 40% thicker than standard L-blades.

#### H-Blades

Recommended for cutting tough materials like plaster board

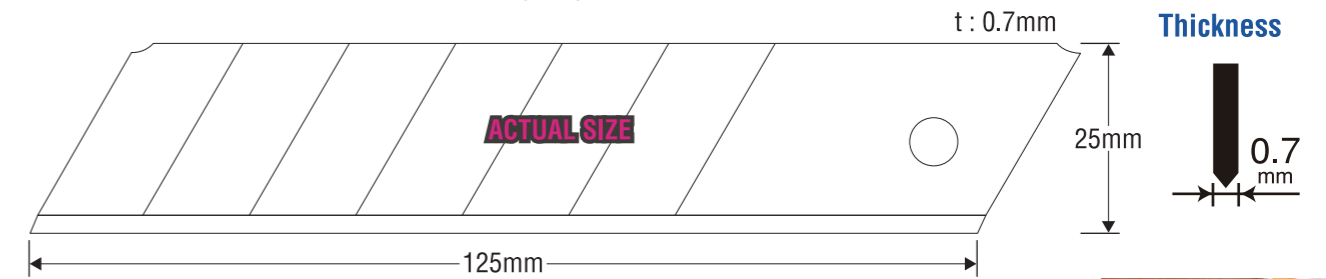

**Application :** for all H-type cutters H-11 H-12 H-12YE-3B H-13 H-16



**G-18 mm**

### Heavy Duty PRO blades

G-blades are 20% thicker than L-blades and more suited for rugged use.

#### G-Blades

Other dimensions are same as L-blades.

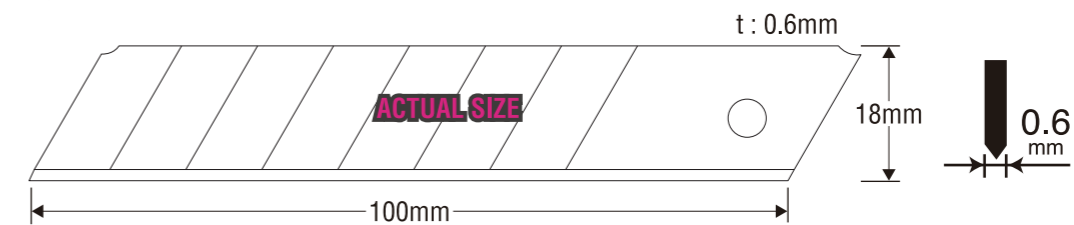

**Application :** for all G-type cutters and GG scrapers



**18 mm**

### Heavy Duty blades

#### L-Blades

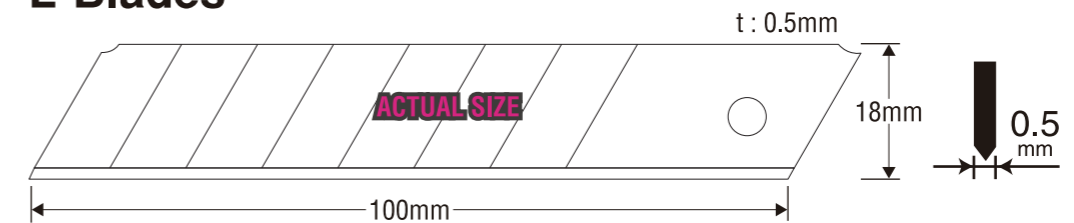

**Application :** for all L-type cutters and GG scrapers



**9 mm**

### Standard Duty blades

#### S-Blades

S-blades are the most popular for general cutting.

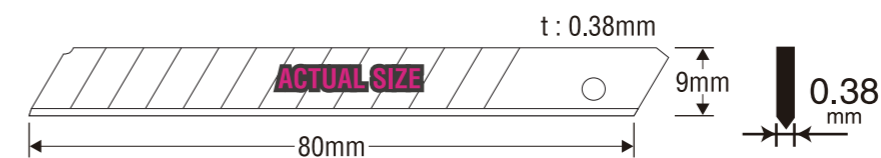

**Application :** for S-11B S-12 S-13 S-14 S-21



## Cutters

### 25 mm H-Blades

H-blades are 40% thicker than standard L-blades.  
Recommended for cutting tough materials like plaster board.

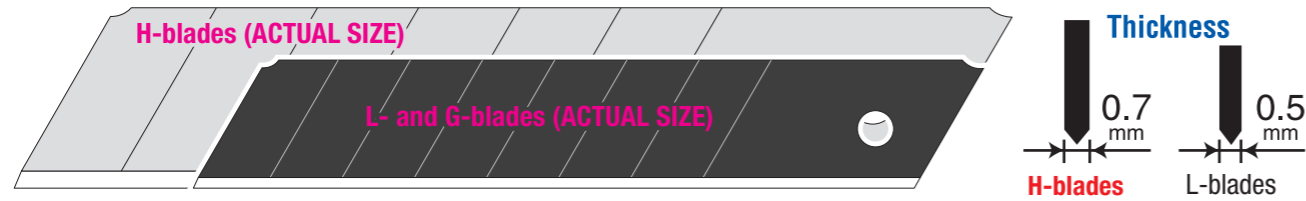

### H-11 Job Boss

YE RE



Extra-heavy-duty cutter with soft rubber grip.  
Screw type slider securely locks the blade in place.

Cat.No.	Handle color	Suitable blade	QTY/ Inner carton	QTY/ Outer carton	N.W.(kgs)	G.W.(kgs)	M3	Carton size (Cm) D x W x H	EAN
H-11YE	Yellow	HB-10 EVO	10	100	20	22	0.079	43.3 x 68 x 26.8	4954183 542252
H-11RE	Red								4954183 542245

### H-12 Job Boss Pro

YE RE



Extra-heavy-duty cutter with strong ABS plastic body.  
Supplied with **one EVO Black H-blade**.

Cat.No.	Handle color	Suitable blade	QTY/ Inner carton	QTY/ Outer carton	N.W.(kgs)	G.W.(kgs)	M3	Carton size (Cm) D x W x H	EAN
H-12YE	Yellow	HB-10B EVO	10	100	18	20	0.080	34.8 x 76.3 x 30	4954183 561222
H-12RE	Red								4954183 561345

### H-13 Job Boss SoftGrip



Extra-heavy-duty cutter with elastomer body.  
Supplied with **one EVO Black H-blade**. Screw type slider securely locks the blade in place

Cat.No.	Handle color	Suitable blade	QTY/ Inner carton	QTY/ Outer carton	N.W.(kgs)	G.W.(kgs)	M3	Carton size (Cm) D x W x H	EAN
H-13	Gray	HB-10B EVO	10	100	17	19	0.080	34.8 x 76.3 x 30	4954183 561260

## Cutters

### H-16 Job Boss Master Pro



Extra-heavy-duty knife with strong ABS plastic body.  
Includes an anti-slip Dragon Grip handle and screw-lock blade for confident cuts.

Cat.No.	Handle color	Suitable blade	QTY/ Inner carton	QTY/ Outer carton	N.W.(kgs)	G.W.(kgs)	M3	Carton size (Cm) D x W x H	EAN
H-16	Black	HB-10B EVO	10	80	16	18	0.080	35 x 76 x 30	4954183 564285

### G-18 mm G-Blades

G-blades are 20% thicker than L-blades and more suited for rugged use.  
Other dimensions are same as L-blades.



### G-11 Safety G

YE RE



Extra heavy-duty texture for long use and good grip with **0.6mm thick blade**. With **2 spare blades stored in the handle**.

Cat.No.	Handle color	Suitable blade	QTY/ Inner carton	QTY/ Outer carton	N.W.(kgs)	G.W.(kgs)	M3	Carton size (Cm) D x W x H	EAN
G-11YE	Yellow	GB-10 EVO	10	100	11	13	0.049	32 x 61 x 25	4954183 542290
G-11RE	Red								4954183 542276

### GC-401



Extra heavy-duty texture for long use and good grip with 0.6mm thick blade.  
With **2 spare blades stored in the handle**.

Cat.No.	Handle color	Suitable blade	QTY/ Inner carton	QTY/ Outer carton	N.W.(kgs)	G.W.(kgs)	M3	Carton size (Cm) D x W x H	EAN
GC-401	Orange	GB-10 EVO	20	100	10.35	11.50	0.027	19 x 55 x 26	4954183 515416

## Cutters

### Grip Fit Series



### G-15 Grip Fit AutoLock G



Rubberized, non-slip grip cutter with automatic locking slider.  
Supplied with 0.6mm thick EVO Black Blades. **2 spare blades stored in the handle.**

Cat.No.	Handle color	Suitable blade	QTY/ Inner carton	QTY/ Outer carton	N.W.(kgs)	G.W.(kgs)	M3	Carton size (Cm) D x W x H	EAN
G-15	Yellow	GB-10B EVO	10	100	12	14	0.068	36.3 x 76 x 24.5	4954183 561512

### G-16 Grip Fit TwistLock G



Rubberized, non-slip grip cutter with twist locking slider.  
Supplied with 0.6mm thick EVO Black Blades. **2 spare blades stored in the handle.**

Cat.No.	Handle color	Suitable blade	QTY/ Inner carton	QTY/ Outer carton	N.W.(kgs)	G.W.(kgs)	M3	Carton size (Cm) D x W x H	EAN
G-16	Yellow	GB-10B EVO	10	100	12	14	0.068	36.3 x 76 x 24.5	4954183 561529

## Cutters

### DRAGON GRIP MultiTip



“MultiTip” is an original term coined by KDS specifically for this product. Unlike standard utility knives, the G-18 and G-19 feature a built-in multi-purpose part called the MultiTip, integrated into the end of the handle. This MultiTip is designed for tucking carpet, prying open paint cans, scoring cardboard, hanging on a pegboard, and more—making it a true multi-function tool for professionals.

### G-18 DRAGON GRIP MultiTip AutoLock G



Auto-lock cutter with automatic locking slider.  
Equipped with a 0.6 mm-thick G-type Power Black Blade.

Cat.No.	Handle color	Suitable blade	QTY/ Inner carton	QTY/ Outer carton	N.W.(kgs)	G.W.(kgs)	M3	Carton size (Cm) D x W x H	EAN
G-18	Black	GB-10B EVO	10	100	8	10	0.068	36.3 x 76 x 24.5	4954183 565022

### G-19 DRAGON GRIP MultiTip TwistLock G



Screw-lock cutter for professional use.  
Equipped with a 0.6 mm-thick G-type Power Black Blade.

Cat.No.	Handle color	Suitable blade	QTY/ Inner carton	QTY/ Outer carton	N.W.(kgs)	G.W.(kgs)	M3	Carton size (Cm) D x W x H	EAN
G-19	Black	GB-10B EVO	10	100	8	10	0.068	36.3 x 76 x 24.5	4954183 565039

# Cutters

## 18 mm L-Blades

### L-11 Safety L YE RE

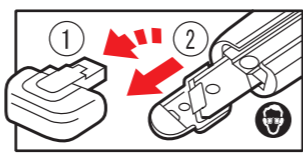
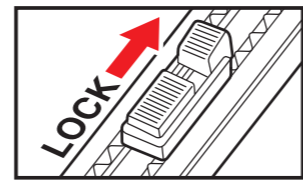

One-handed safety lock. Supplied with **2 spare blades stored in the handle.**

Cat.No.	Handle color	Suitable blade	QTY/ Inner carton	QTY/ Outer carton	N.W.(kgs)	G.W.(kgs)	M3	Carton size (Cm) D x W x H	EAN
L-11YE	Yellow	LB-10 EVO	10	100	11	13	0.049	32 x 61 x 25	4954183 542320
L-11RE	Red								4954183 548827

### LC-405

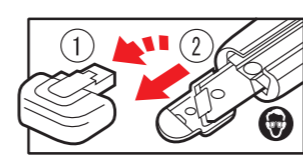

One-handed safety lock. Supplied with **2 spare blades stored in the handle.**



Cat.No.	Handle color	Suitable blade	QTY/ Inner carton	QTY/ Outer carton	N.W.(kgs)	G.W.(kgs)	M3	Carton size (Cm) D x W x H	EAN
LC-405	Orange	LB-10 EVO	20	100	9.45	10.50	0.027	19 x 55 x 26	4954183 515614

# Cutters

### L-15 Big Twist YE



Multi-purpose screw type cutter for professional use, with **2 spare blades stored in the handle.**

Cat.No.	Handle color	Suitable blade	QTY/ Inner carton	QTY/ Outer carton	N.W.(kgs)	G.W.(kgs)	M3	Carton size (Cm) D x W x H	EAN
L-15YE	Yellow	LB-10 EVO	10	100	12	14	0.079	43.3 x 68 x 26.8	4954183 542238

### L-18EL 雅 (Mi-Ya-Bi) The Elegance BL



Why must hand tools be so plain?  
 Add style to your tools with the KDS 雅 (Mi-Ya-Bi), which means "The Elegance".  
 With the KDS 雅 (Mi-Ya-Bi), be proud to express your personality and stand out in the crowd!  
**1 spare blade stored in the handle.**

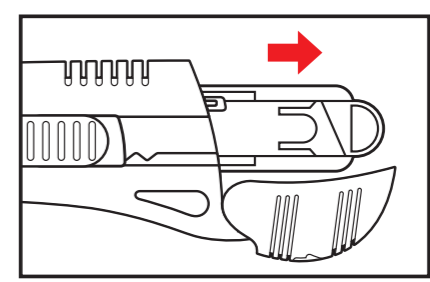

Cat.No.	Handle color	Suitable blade	QTY/ Inner carton	QTY/ Outer carton	N.W.(kgs)	G.W.(kgs)	M3	Carton size (Cm) D x W x H	EAN
L-18EL BL	Metallic Blue	LB-10B EVO	10	60	6	8	0.033	37 x 48.5 x 18.3	4954183 525279



## Cutters

### L-18 Auto Lock

YE RE

 × 3 (1+2) 

L-18YE

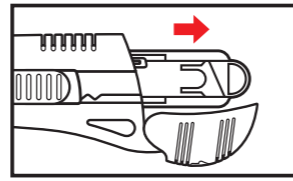

L-18RE



L-18YEB



Auto-lock cutter with automatic locking slider. Supplied with **2 spare blades stored in the handle.**

Cat.No.	Handle color	Suitable blade	QTY/ Inner carton	QTY/ Outer carton	N.W.(kgs)	G.W.(kgs)	M3	Carton size (Cm) D x W x H	EAN
L-18YE	Yellow	LB-10 EVO	10	100	11	13	0.068	36.3 x 76 x 24.5	4954183 554064
L-18RE	Red								4954183 554057
L-18YEB	Yellow	LB-10B EVO							4954183 522049

## Cutters

### L-19 Twist L

YE RE

 × 3 (1+2) 

L-19YE

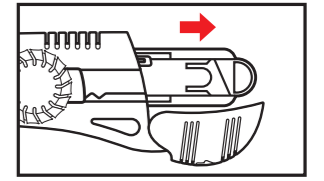

L-19RE



L-19YEB



"Twist-Lock" for safe and secure cutting. With **2 spare blades stored in the handle.**

Cat.No.	Handle color	Suitable blade	QTY/ Inner carton	QTY/ Outer carton	N.W.(kgs)	G.W.(kgs)	M3	Carton size (Cm) D x W x H	EAN
L-19YE	Yellow	LB-10 EVO	10	100	11	13	0.068	36.3 x 76 x 24.5	4954183 554088
L-19RE	Red								4954183 554071
L-19YEB	Yellow	LB-10B EVO							4954183 522056

## Cutters

### L-18SS STAINLESS Blade AutoLock × 1



Auto-lock cutter with STAINLESS BLADE.  
This cutter is recommended for outdoor or wet working environments.

Stainless steel blade

Cat.No.	Handle color	Suitable blade	QTY/ Inner carton	QTY/ Outer carton	N.W.(kgs)	G.W.(kgs)	M3	Carton size (Cm) D x W x H	EAN
L-18SS	Black	LB-10S EVO	10	100	10	12	0.068	36.3 x 76 x 24.5	4954183 521554

### L-21 Auto Feeder × 3

L-21YE



A three-blade, auto-feeding magazine to keep a sharp edge for a longer time. **Three L-blades pre-loaded.**  
Auto-lock for regular use and a pro screw lock for power cuts.  
**This cutter accepts both heavy-duty L-blades (0.5mm thickness) and heavy-duty pro G-blades (0.6mm thickness).**

Cat.No.	Handle color	Suitable blade	QTY/ Inner carton	QTY/ Outer carton	N.W.(kgs)	G.W.(kgs)	M3	Carton size (Cm) D x W x H	EAN
L-21YE	Yellow	LB-10 EVO	10	100	12	14	0.079	32 x 61x 25	4954183 559946

## Cutters

### Grip Fit Series



Rubberized, Non-Slip Grip

2 spare blades stored in the handle.

### L-22 GripFit AutoLock L × 3 (1+2)



Rubberized, non-slip grip cutter with automatic locking slider. Supplied with EVO Black Blades.  
**2 spare blades stored in the handle.**

Cat.No.	Handle color	Suitable blade	QTY/ Inner carton	QTY/ Outer carton	N.W.(kgs)	G.W.(kgs)	M3	Carton size (Cm) D x W x H	EAN
L-22	Yellow	LB-10B EVO	10	100	14	16	0.068	36.3 x 76 x 24.5	4954183 509132

### L-23 GripFit TwistLock L × 3 (1+2)



Rubberized, non-slip grip cutter with twist lock slider. Supplied with EVO Black Blades. **2 spare blades stored in the handle.**

Cat.No.	Handle color	Suitable blade	QTY/ Inner carton	QTY/ Outer carton	N.W.(kgs)	G.W.(kgs)	M3	Carton size (Cm) D x W x H	EAN
L-23	Yellow	LB-10B EVO	10	100	14	16	0.068	36.3 x 76 x 24.5	4954183 509149

## Cutters

### MultiPro Series

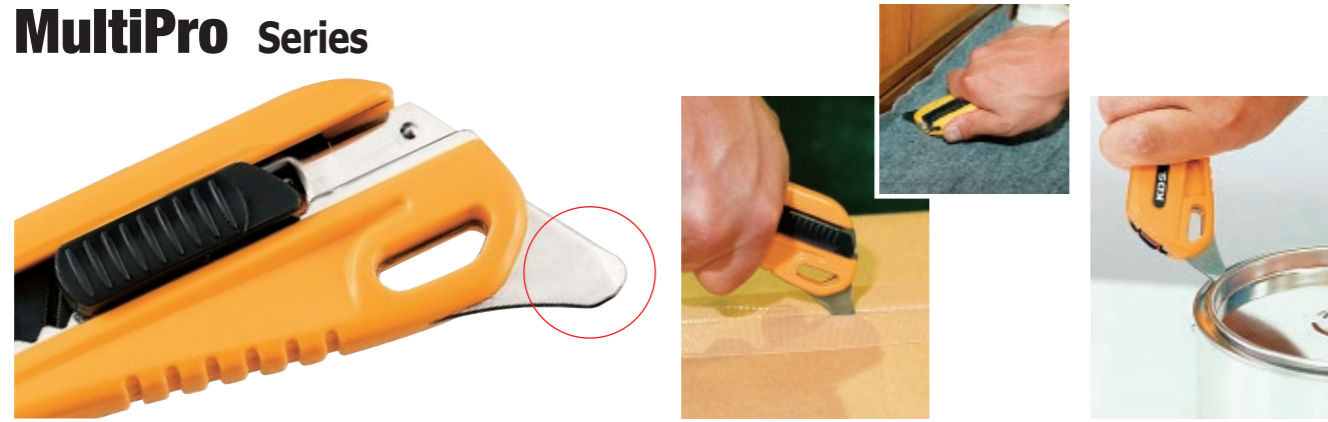

### L-24 MultiPro AutoLock L



"MultiPro L series" is not only for cutting.

Can be used for tucking carpet, prying lids off paint and other cans, and scoring & cut cardboard to make boxes. Supplied with **EVO Black Blades**.

Cat.No.	Handle color	Suitable blade	QTY/ Inner carton	QTY/ Outer carton	N.W.(kgs)	G.W.(kgs)	M3	Carton size (Cm) D x W x H	EAN
L-24	Yellow	LB-10B EVO	10	100	8	10	0.068	36.3 x 76 x 24.5	4954183 510749

### L-25 MultiPro TwistLock L



"MultiPro L series" is not only for cutting.

Can be used for tucking carpet, prying lids off paint and other cans, and scoring & cut cardboard to make boxes. Supplied with **EVO Black Blades**.

Cat.No.	Handle color	Suitable blade	QTY/ Inner carton	QTY/ Outer carton	N.W.(kgs)	G.W.(kgs)	M3	Carton size (Cm) D x W x H	EAN
L-25	Yellow	LB-10B EVO	10	100	8	10	0.068	36.3 x 76 x 24.5	4954183 510756

## Cutters

### L-30 Finger Guard



Recommendable for professionals as well as DIY users.

Finger protection bar stabilizes the cutting depth, compresses insulation, and keeps fingers away from the exposed blade. Screw type slider securely locks the blade in place.

Supplied with **EVO Black Blades**. **2 spare blades stored in the handle.**

Good fit with SAW blade(HSB) to cut Wood and Plasterboard.

Cat.No.	Handle color	Suitable blade	QTY/ Inner carton	QTY/ Outer carton	N.W.(kgs)	G.W.(kgs)	M3	Carton size (Cm) D x W x H	EAN
L-30	Yellow	LB-10B EVO	10	100	10	12	0.068	38.8 x 85 x 26	4954183 561604

### L-32 Metal Meister Twist Lock



Aluminum die-cast body with twist locking slider. Ergonomically designed body shape perfectly stays in your palm.

End cap works as a blade snapper. Supplied with **EVO Black Blades**.

Cat.No.	Handle color	Suitable blade	QTY/ Inner carton	QTY/ Outer carton	N.W.(kgs)	G.W.(kgs)	M3	Carton size (Cm) D x W x H	EAN
L-32	Metallic Gray	LB-10B EVO	10	60	7.7	8.7	0.026	42 x 23.5 x 26	4954183 530655

### L-33 Metal Meister Auto Lock



Aluminum die-cast body with automated locking slider. Ergonomically designed body shape perfectly stays in your palm.

End cap works as a blade snapper. Supplied with **EVO Black Blades**.

Cat.No.	Handle color	Suitable blade	QTY/ Inner carton	QTY/ Outer carton	N.W.(kgs)	G.W.(kgs)	M3	Carton size (Cm) D x W x H	EAN
L-33	Metallic Gray	LB-10B EVO	10	60	8	9	0.026	42 x 23.5 x 26	4954183 563363

## Cutters

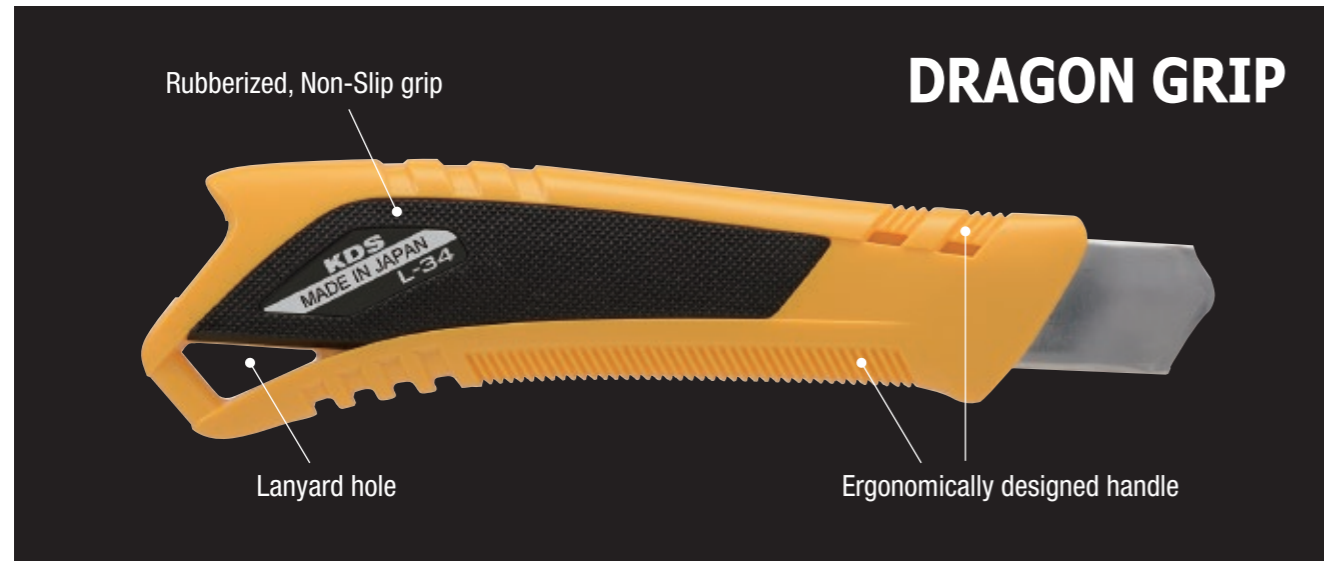

### L-34 Auto Lock



Heavy-duty cutter with automatic locking slider and lanyard hole. Ergonomically designed body shape perfectly stays in your palm. Supplied with **one blade**.

Cat.No.	Handle color	Suitable blade	QTY/ Inner carton	QTY/ Outer carton	N.W. (kgs)	G.W. (kgs)	M3	Carton size (Cm) D x W x H	EAN
L-34YE	Yellow	LB-10 EVO	10	100	10	12	0.068	36.3 x 76 x 24.5	4954183 563844

### L-35 Twist Lock



Heavy-duty cutter with twist-locking slider and lanyard hole. Ergonomically designed body shape perfectly stays in your palm. Supplied with **one blade**.

Cat.No.	Handle color	Suitable blade	QTY/ Inner carton	QTY/ Outer carton	N.W. (kgs)	G.W. (kgs)	M3	Carton size (Cm) D x W x H	EAN
L-35YE	Yellow	LB-10 EVO	10	100	10	12	0.068	36.3 x 76 x 24.5	4954183 563851

## Cutters

### 9 mm S-Blades

S-blades are the most popular for general cutting.

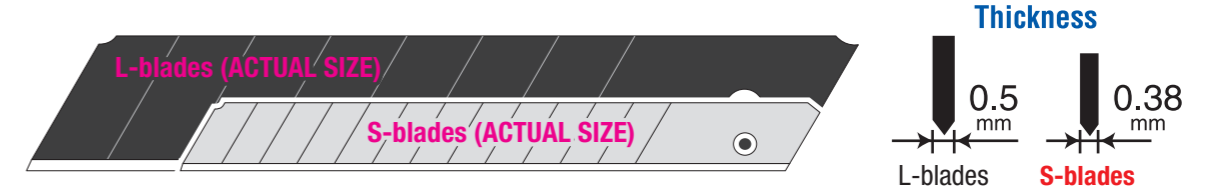

### S-11B Slim Black



Stainless frame with sliding lock.

One slide position matches every break point of the multiple break-off blade.

With **2 spare blades**.

Cat.No.	Handle color	Suitable blade	QTY/ Inner carton	QTY/ Outer carton	N.W.(kgs)	G.W.(kgs)	M3	Carton size (Cm) D x W x H	EAN
S-11B	Silver	SB-10B EVO	10	200	8.5	9.5	0.047	24.5 x 43 x 44	4954183 532130

### S-12 Metal Slim



Stainless frame with sliding lock. One slide position matches every break point of the multiple break-off blade.

With **2 spare blades**.

Cat.No.	Handle color	Suitable blade	QTY/ Inner carton	QTY/ Outer carton	N.W.(kgs)	G.W.(kgs)	M3	Carton size (Cm) D x W x H	EAN
S-12	Silver	SB-10 EVO	10	200	8.4	9.4	0.047	24.5 x 43 x 44	4954183 542016

### S-13 Dura Slim



S-13BL



S-13GR



Electronic powder coated metal frame with sliding lock. 9 mm snap-off with 13 segments. With **2 spare blades**.

Cat.No.	Handle color	Suitable blade	QTY/ Inner carton	QTY/ Outer carton	N.W.(kgs)	G.W.(kgs)	M3	Carton size (Cm) D x W x H	EAN
S-13BL	Blue	SB-10 EVO	10	200	8.4	9.4	0.048	22.5 x 48.5 x 44	4954183 542047
S-13GR	Green								4954183 542061

## Cutters

### S-14 Pocket Slim

YE GR BL

 × 3 (1+2) 

S-14YE



S-14BL



S-14GR



S-14YEB



Impact resistant body in high-quality ABS material, with metal blade sleeve. 9 mm snap-off with 13 segments.

With **2 spare blades**.

Cat.No.	Handle color	Suitable blade	QTY/ Inner carton	QTY/ Outer carton	N.W.(kgs)	G.W.(kgs)	M3	Carton size (Cm) D x W x H	EAN
S-14YE	Yellow	SB-10 EVO	10	200	8.4	9.4	0.047	24.5 x 43 x 44	4954183 542108
S-14BL	Blue								4954183 542092
S-14GR	Green								4954183 542115
S-14YEB	Yellow	SB-10B EVO							4954183 521363

### Non - SPARE BLADE

YE

 × 1 

S-14YE NB	Yellow	SB-10 EVO	10	200	8.4	9.4	0.047	24.5 x 43 x 44	4954183 525316
-----------	--------	-----------	----	-----	-----	-----	-------	----------------	----------------

### S-18 Slim Trim

 × 1 



Snap-Edge Cutter is most convenient for delicate cutting work, with special **30 degree angle blade**.

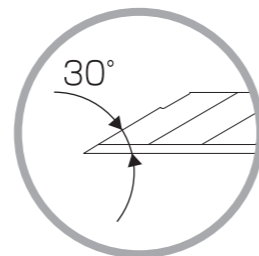

Suitable blade : VB-10 EVO

Cat.No.	Handle color	Suitable blade	QTY/ Inner carton	QTY/ Outer carton	N.W.(kgs)	G.W.(kgs)	M3	Carton size (Cm) D x W x H	EAN
S-18	Silver	VB-10 EVO	10	200	7	8	0.047	24.5 x 43 x 44	4954183 553692

## Cutters

### S-21 Easy Slim

 × 1 

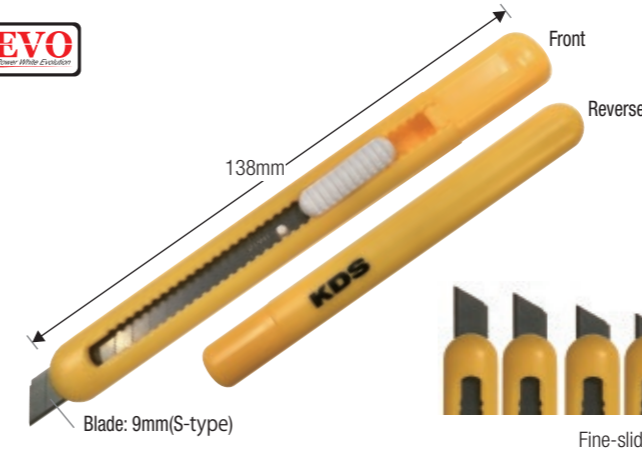

Blade snapper



Nylon bag for hanging

Small size cutter with fine-slider for delicate cutting work. Supplied with **one blade**.

Cat.No.	Handle color	Suitable blade	QTY/ Inner carton	QTY/ Outer carton	N.W.(kgs)	G.W.(kgs)	M3	Carton size (Cm) D x W x H	EAN
S-21	Yellow	SB-10 EVO	20	720	8	9.5	0.043	27.5 x 40.5 x 39	4954183 562922

### D-12 Easy Grip

BL YE

 × 16 





Most useful and convenient for all graphic work. Soft grip allows for precise use, and 10.5mm diameter body for tireless grip. With **16 pcs of spare blades** which can be stored inside the handle.

Cat.No.	Handle color	Suitable blade	QTY/ Inner carton	QTY/ Outer carton	N.W.(kgs)	G.W.(kgs)	M3	Carton size (Cm) D x W x H	EAN
D-12BL	Blue	DB-48	10	200	7.6	8.6	0.048	22.5 x 48.5 x 44	4954183 555054
D-12YE	Yellow								4954183 557904

### P-11 Plastic Cutter

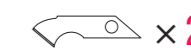
YE

 × 2  × 2 

P-11YE



PB-10

PB-10 A

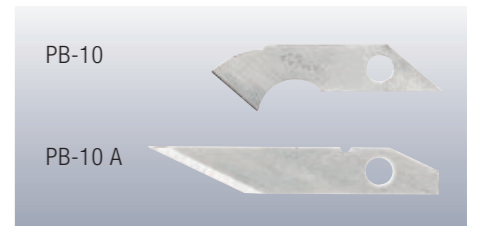

P-Cutter is most convenient for plastic cutting.

**2 straight and 1 hook blades stored in the handle.**

Cat.No.	Handle color	Suitable blade	QTY/ Inner carton	QTY/ Outer carton	N.W.(kgs)	G.W.(kgs)	M3	Carton size (Cm) D x W x H	EAN
P-11YE	Yellow	PB-10 (Hook blade)/ PB-10A (Sharper)	10	100	6.4	7.4	0.049	32 x 61 x 25	4954183 542375

## Cutters

### T-11 Threeway

YE

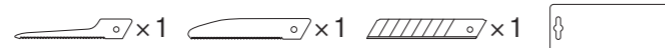

Multi-purpose cutter and standard / keyhole saws.  
Most useful for electricians, carpenters and gardeners.

Cat.No.	Handle color	Suitable blade	QTY/ Inner carton	QTY/ Outer carton	N.W. (kgs)	G.W. (kgs)	M3	Carton size (Cm) D x W x H	EAN
T-11YE	Yellow	All L-type blades, HSB-Z and HSB-W	5	50	9	11	0.062	39.3 x 47 x 33.3	4954183 542399

### HOOK BLADE SERIES

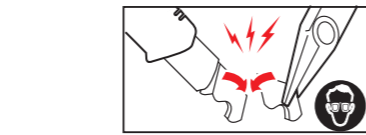
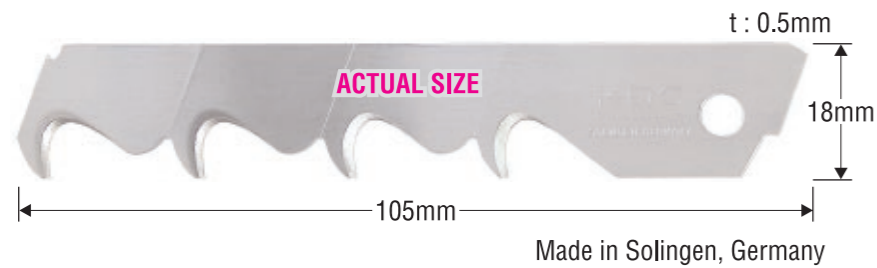

### HK-11 Twist L-Hook



Hook it! Slices through materials without damaging the surface. Use it for flooring and roofing, to cut strapping and boxes. **Supplied with 1 Hook Blade from Solingen, Germany.**

Cat.No.	Handle color	Suitable blade	QTY/ Inner carton	QTY/ Outer carton	N.W.(kgs)	G.W.(kgs)	M3	Carton size (Cm) D x W x H	EAN
HK-11	Yellow	HK-5 EVO	10	100	8	10	0.068	36.3 x 76 x 24.5	4954183 507787

### HK-12 MultiPro Hook it

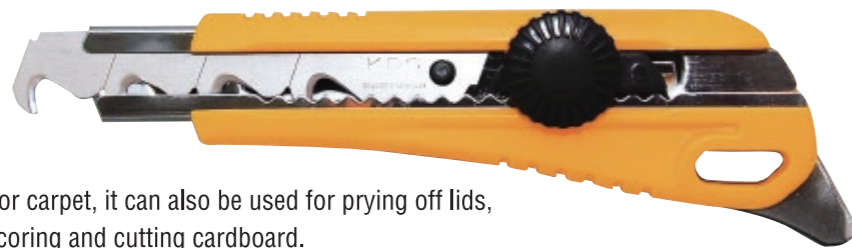

With the tucker is great for carpet, it can also be used for prying off lids, tightening screws, and scoring and cutting cardboard.

The knife is loaded with a snap hook blade for cutting surface materials without damaging what is underneath.

**Supplied with 1 Hook Blade from Solingen, Germany.**

Cat.No.	Handle color	Suitable blade	QTY/ Inner carton	QTY/ Outer carton	N.W.(kgs)	G.W.(kgs)	M3	Carton size (Cm) D x W x H	EAN
HK-12	Yellow	HK-5 EVO	10	100	8	10	0.068	36.3 x 76 x 24.5	4954183 512323

## Cutters

### SA-11B Safety Master

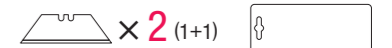

EVO



Ergonomically designed safety knife changes the image of the common safety knife! Rubberized, non-slip grip and lightweight body for comfortable long-term use.

**One blade loaded and one spare in the handle.**



Anti-lock, recessed slider



One push open for blade change

Cat.No.	Handle color	Suitable blade	QTY/ Inner carton	QTY/ Outer carton	N.W. (kgs)	G.W. (kgs)	M3	Carton size (Cm) D x W x H	EAN
SA-11B	Yellow	TB-5B/TB-50B	10	100	10	12	0.056	36.3 x 76 x 24.5	4954183 539948

### SA-12B Safety Metal

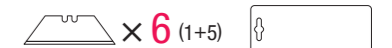

EVO



Aluminum die-cast body Safety cutter.

Ergonomically designed grip perfectly fits your palm.

Suitable for right and left handers.

**Comes with 5 spare blades.**

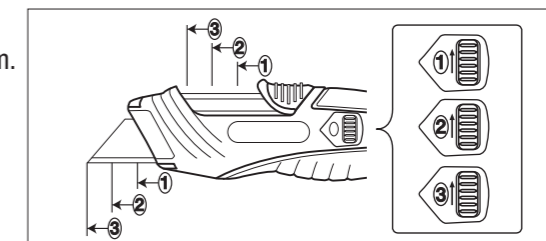

Cat.No.	Handle color	Suitable blade	QTY/ Inner carton	QTY/ Outer carton	N.W. (kgs)	G.W. (kgs)	M3	Carton size (Cm) D x W x H	EAN
SA-12B	Metallic Silver	TB-5B/TB-50B	6	36	8.5	9.5	0.023	34.5 x 26.5 x 25	4954183 531959

# Cutters

## SA-14 Safety Metal Pro

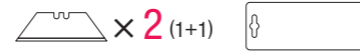

Even if the user forgets to release the slider, the cutter can still be used safely and effectively because the **CLICK**ed blade retracts automatically.



**A spare blade in the handle.**  
(Can be opened without any tool)



Useful for safely cutting strings!

Self-Retracting safety knife provides an extra level of safety function. The blade automatically retracts when it loses contact with the cutting materials, even if the slider is kept at the forward position.

**One blade loaded and one spare in the handle.**

Cat.No.	Handle color	Suitable blade	QTY/ Inner carton	QTY/ Outer carton	N.W. (kgs)	G.W. (kgs)	M3	Carton size (Cm) D x W x H	EAN
SA-14	Black	TB-5B/TB-50B	6	36	8.7	9.5	0.021	27.5 x 24 x 30.5	4954183 531331

# Cutter packaging-1

Cat.No.	QTY/Inner carton	QTY/Outer carton		
SA-15		8		
<b>25mm</b>		Packed 8 inner cartons		
H-11YE			80	
H-11RE				
H-12YE				
H-12RE				
H-13				
<b>G-18mm</b>		10		
G-11YE		Packed 10 inner cartons		
G-11RE			100	
G-15				
G-16				
G-18				
G-19				
GC-401		20		
<b>18mm</b>		Packed 5 inner cartons		
LC-405		100		
L-11YE				
L-11RE		Packed 10 inner cartons		
L-15YE				
L-15RE		60		
L-18EL BL			Packed 6 inner cartons	
L-18YE		10		
L-18RE			Packed 10 inner cartons	
L-18YEB				
L-19YE				
L-19RE				
L-19YEB				
L-18SS				
L-21YE				
L-22				
L-23		100		
L-24				
L-25				
L-30				
L-32				10
L-33				Packed 6 inner cartons
L-34				10
L-35				

## Cutter packaging-2

Cat.No.	QTY/Inner carton 	QTY/Outer carton 					
<b>9mm</b>							
S-11B		10					
S-12							
S-13BL							
S-13GR							
S-14YE							
S-14BL							
S-14GR							
S-14YEB							
S-14YE NB							
S-18	Packed 20 inner cartons	200					
<b>Others</b>							
S-21				20		Packed 36 inner cartons	720
D-12BL				10		Packed 20 inner cartons	200
D-12YE							
P-11YE							
T-11				5		Packed 10 inner cartons	100
HK-11				10			50
SA-11B				6		Packed 6 inner cartons	100
SA-12B	36						
SA-14	36						
<b>Package-Deals</b>							
LC-405 5H		20		Packed 4 inner cartons	80		
L-18 5H							
L-19 5H							
H-12YE-3B		18		Packed 1 inner carton	18		

## Spare Blades

# Hard but Pliable

KDS black blades have undergone the ideal heat treatment for cutter blades.

**Made in Japan**

The **Blade** is the heart of the knife.

KDS provides first class blades with over 50 years of know-how and strict quality control systems.

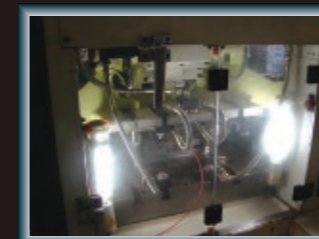

Press



Heat Treatment



Edging



Control board



Surface Inspecting



Cutting Test



Photo : OITA factory, JAPAN



# KDS® Evolution

An Evolution in Knife Blades  
KDS introduces the world's finest blades!



**SHARP EDGE**  
Designed for Maximum Sharpness



**DURABLE EDGE**  
Designed for Maximum Durability

## Why are EVO blades better?

### Quality Steel



Only the best steel for the best blades!

### Tempering



Tempered for the optimum balance of hardness and pliability.

### Honing Angles

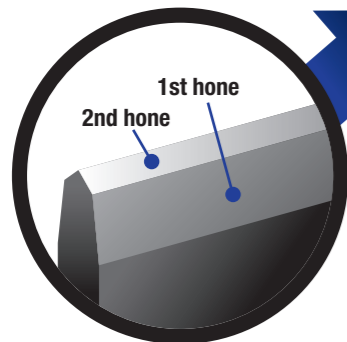

Double-honed, ideal for the job.

### Grinding

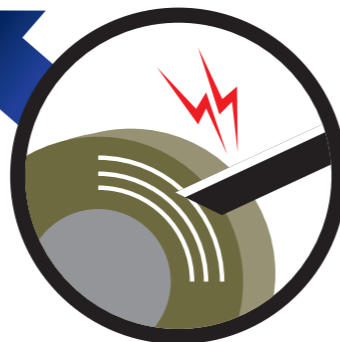

Ground for a smooth, clean cut.



## Paper cutting test

**Purpose :** To test Blade Sharpness and Durability

750g of weight is loaded on the blade, and the full blade is pulled through a stack of newsprint that is 7.5mm wide. After each pass, the number of cut sheets is measured. The test is repeated 32 times per blade.

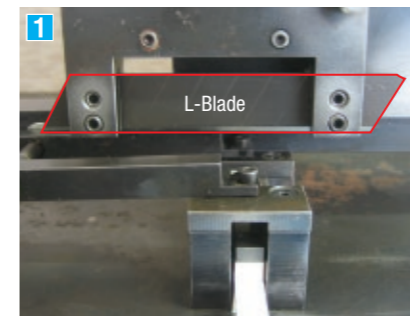

Step 1 : Setting up a blade

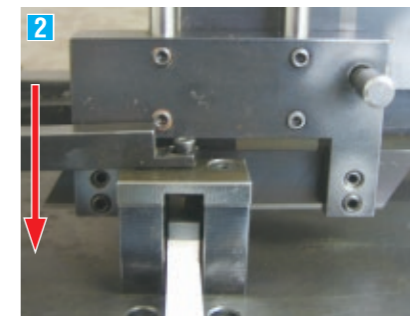

Step 2 : Cutting the paper with 750g weight

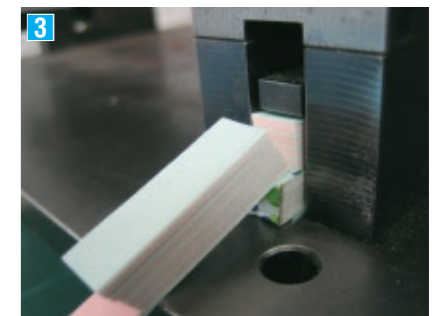

Step 3 : Measuring the cut sheets

**TEST RESULT** Based on our internal test Number of sheets cut and number of passes made

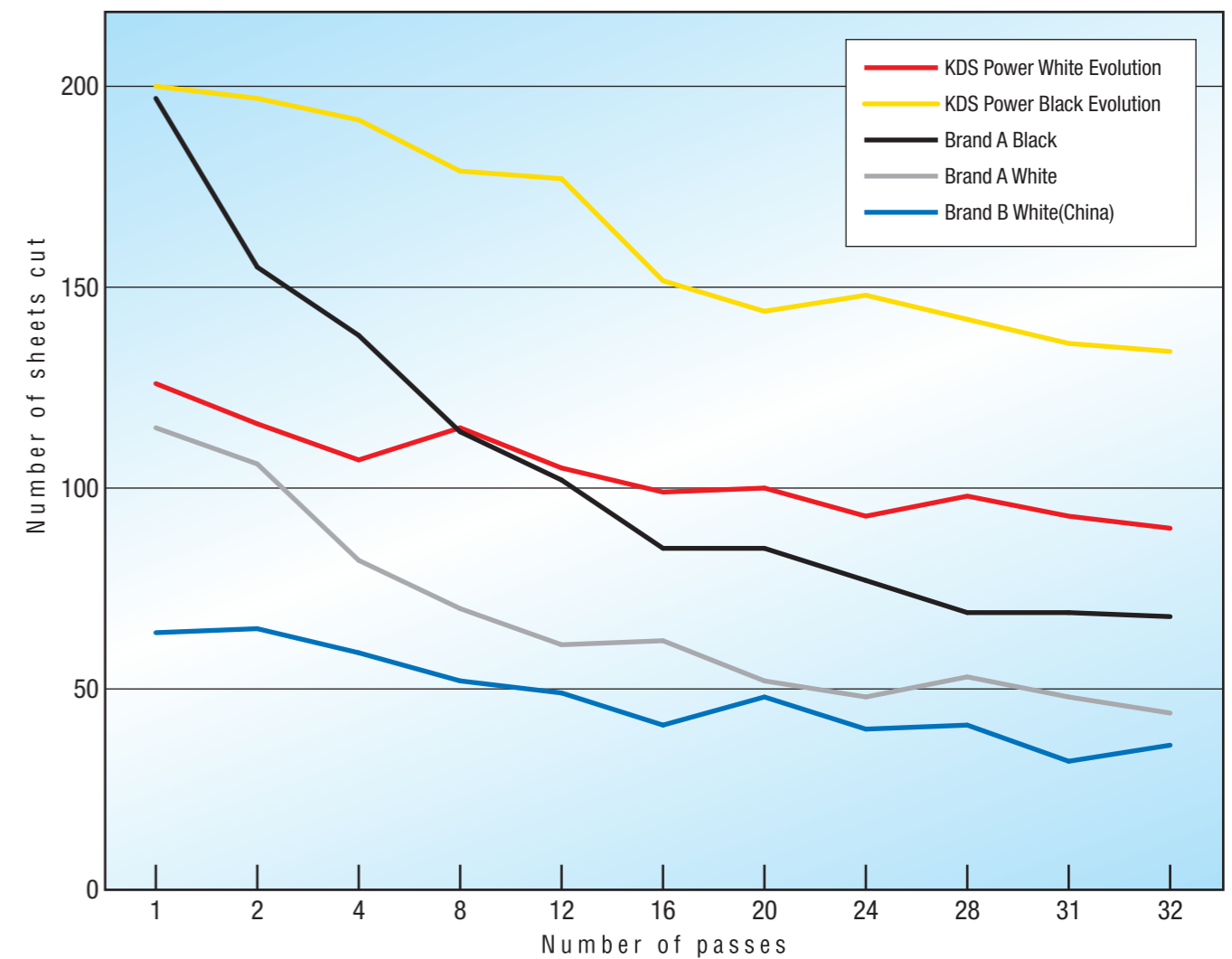

**Choose the blade that's right for the job!**

## Spare Blades Packaging

### Display box



9 mm

#### S-Blades

SB-10B EVO SB-50B EVO  
SB-10 EVO SB-50 EVO  
SB-10BNL EVO SB-50BNL EVO  
SB-10NL EVO SB-50NL EVO  
VB-10 EVO



G-18 mm

#### G-Blades

GB-10B EVO  
GB-10 EVO  
GB-10W EVO  
GB-10NL EVO

18 mm

#### L-Blades

LB-10B EVO GB-50B EVO  
LB-10 EVO GB-50 EVO  
LB-10BW EVO GB-50W EVO  
LB-10W EVO GB-50WOF EVO  
LB-10BNL EVO  
LB-10NL EVO LB-50B EVO  
LB-10S EVO LB-50 EVO  
LB-10SNL EVO LB-50W EVO  
HK-5 EVO LB-50BNL EVO  
LB-50NL EVO



#### Trapezoidal Blade

TB-5B

### Plain box



25 mm

#### H-Blades

HB-5B EVO HB-10BNL EVO  
HB-10B EVO HB-10NL EVO  
HB-10 EVO



#### Others

HSB-W PB-10  
HSB-Z PB-10A  
DB-45



#### Trapezoidal Blade

TB-50B

## Spare Blades

25 mm

### Extra Heavy Duty blades

#### H-Blades

H-blades are 40% thicker than standard L-blades.  
Recommended for cutting tough materials like plaster board

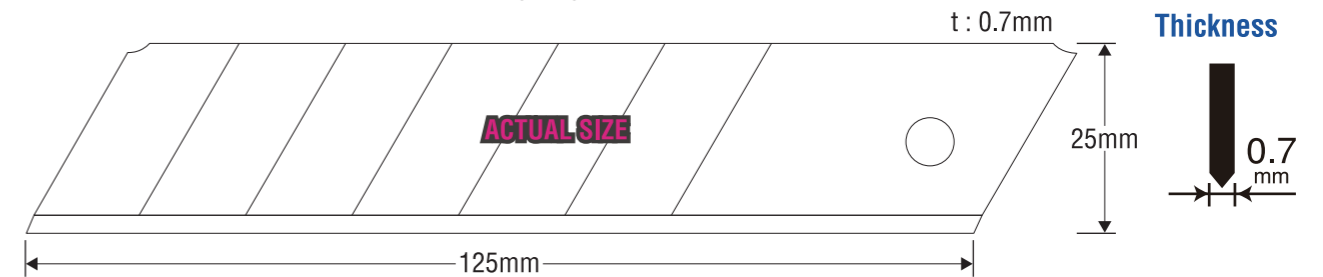

Application : for all H-type cutters H-11 H-12 H-12YE-3B H-13 H-16



G-18 mm

### Heavy Duty PRO blades

#### G-Blades

G-blades are 20% thicker than L-blades and more suited for rugged use.  
Other dimensions are same as L-blades.

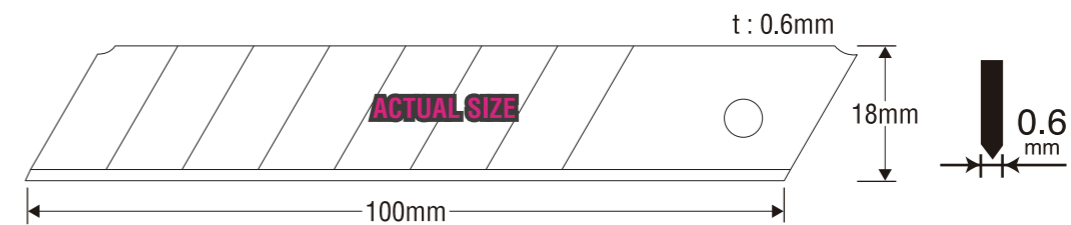

Application : for all G-type cutters and GG scrapers



18 mm

### Heavy Duty blades

#### L-Blades

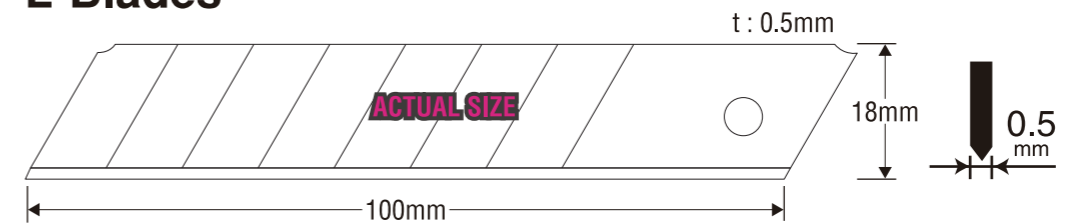

Application : for all L-type cutters and GG scrapers



9 mm

### Standard Duty blades

#### S-Blades

S-blades are the most popular for general cutting.

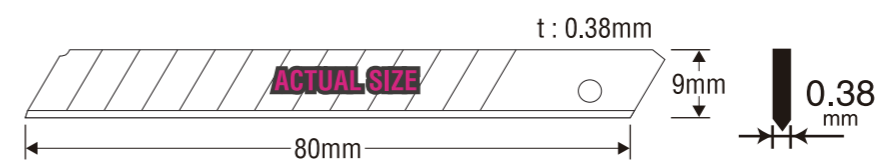

Application : for S-11B S-12 S-13 S-14 S-21



## Spare Blades

### EVO Black Trapezoidal Blade

**KDS trapezoidal blades** are developed using the proprietary heat treatment technology of the Power Black Evolution series.

#### Features:

- 1 High-quality steel with KDS's superior tempering process
- 2 KDS original double-hones, ideal for the job
- 3 Made in Japan by KDS



TB-5B

TB-50B



Tear off the box corner to make a convenient counter display!



STORAGE CASE

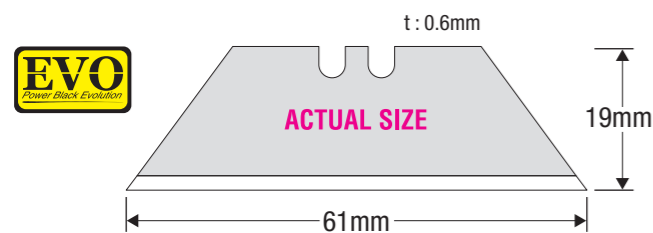

Application : SA-11B SA-12B SA-14

Cat.No.	Number of blades in a case	QTY/ Inner carton	QTY/ Outer carton	N.W. (kgs)	G.W. (kgs)	M3	Carton size (Cm) D x W x H	EAN
TB-5B	5	20	200	9	10	0.012	27 x 24.5 x 17.5	4954183 530785
TB-50B	50	8	48	13.5	14.5	0.047	61.5 x 31.5 x 24	4954183 530792

## Spare Blades

### H-Blades <sup>25mm</sup>

#### EVO SHARP EDGE

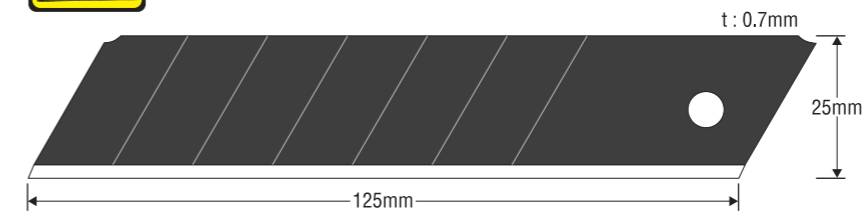

Cat.No.	Number of blades in a case	QTY/ Inner carton	QTY/ Outer carton	N.W. (kgs)	G.W. (kgs)	M3	Carton size (Cm) D x W x H	EAN
HB-5B EVO	5	10	100	10	12	0.006	17 x 19 x 18.5	4954183 524784
HB-10B EVO	10	100	20	22	4954183 524791			

#### EVO DURABLE EDGE

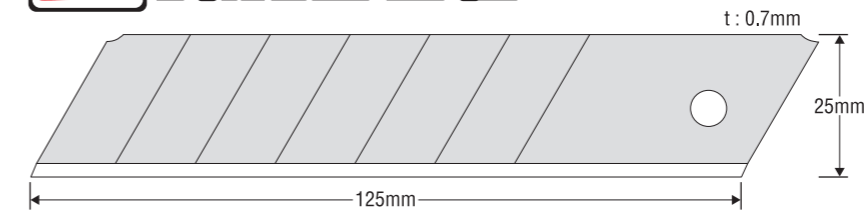

Cat.No.	Number of blades in a case	QTY/ Inner carton	QTY/ Outer carton	N.W. (kgs)	G.W. (kgs)	M3	Carton size (Cm) D x W x H	EAN
HB-10 EVO	10	10	100	20	22	0.006	17 x 19 x 18.5	4954183 524807

### Non-Snap Series Solid blades, non-snap blades for special purpose

#### EVO SHARP EDGE



Cat.No.	Number of blades in a case	QTY/ Inner carton	QTY/ Outer carton	N.W. (kgs)	G.W. (kgs)	M3	Carton size (Cm) D x W x H	EAN
HB-10BNL EVO	10	10	100	20	22	0.006	17 x 19 x 18.5	4954183 524814

#### EVO DURABLE EDGE



Cat.No.	Number of blades in a case	QTY/ Inner carton	QTY/ Outer carton	N.W. (kgs)	G.W. (kgs)	M3	Carton size (Cm) D x W x H	EAN
HB-10NL EVO	10	10	100	20	22	0.006	17 x 19 x 18.5	4954183 524821

## Spare Blades

### G-Blades G-18 mm

**EVO SHARP EDGE**

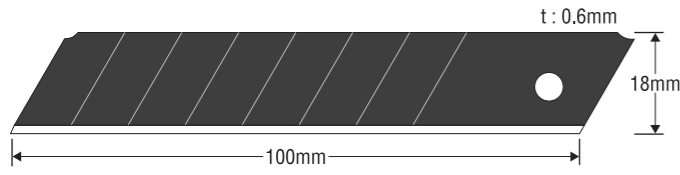

GB-10B EVO

GB-50B EVO

Cat.No.	Number of blades in a case	QTY/ Inner carton	QTY/ Outer carton	N.W. (kgs)	G.W. (kgs)	M3	Carton size (Cm) D x W x H	EAN
GB-10B EVO	10	20	200	19	21	0.014	24 x 36 x 15.5	4954183 524715
GB-50B EVO	50	10	50	21	23	0.011	15 x 45 x 16.5	4954183 524722

**EVO DURABLE EDGE**

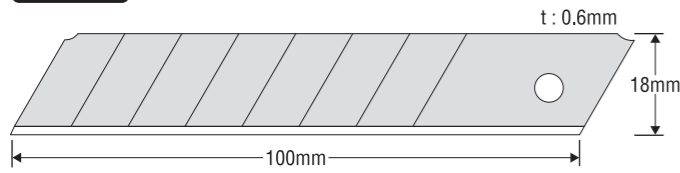

GB-10 EVO

GB-50 EVO

Cat.No.	Number of blades in a case	QTY/ Inner carton	QTY/ Outer carton	N.W. (kgs)	G.W. (kgs)	M3	Carton size (Cm) D x W x H	EAN
GB-10 EVO	10	20	200	19	21	0.014	24 x 36 x 15.5	4954183 524739
GB-50 EVO	50	10	50	21	23	0.011	15 x 45 x 16.5	4954183 524746

### 15 segments Blades

**EVO DURABLE EDGE**

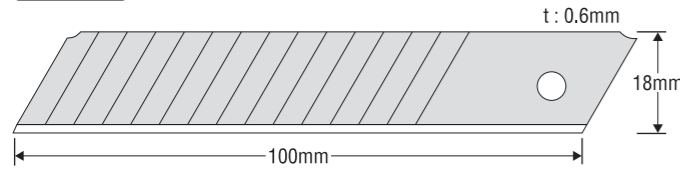

GB-10W EVO

GB-50W EVO

Cat.No.	Number of blades in a case	QTY/ Inner carton	QTY/ Outer carton	N.W. (kgs)	G.W. (kgs)	M3	Carton size (Cm) D x W x H	EAN
GB-10W EVO	10	20	200	19	21	0.014	24 x 36 x 15.5	4954183 524753
GB-50W EVO	50	10	50	21	23	0.011	15 x 45 x 16.5	4954183 524760

### OIL FREE Blades

**EVO DURABLE EDGE**

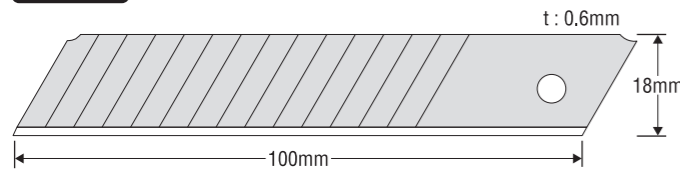

GB-50WOF EVO

Cat.No.	Number of blades in a case	QTY/ Inner carton	QTY/ Outer carton	N.W. (kgs)	G.W. (kgs)	M3	Carton size (Cm) D x W x H	EAN
GB-50WOF EVO	50	10	50	21	23	0.011	15 x 45 x 16.5	4954183 563936

## Spare Blades

### L-Blades 18 mm

**EVO SHARP EDGE**

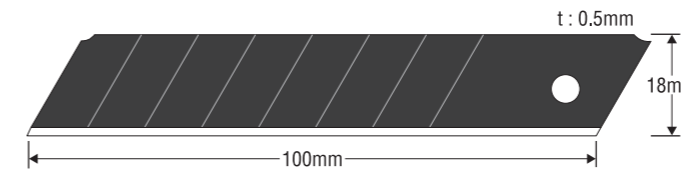

LB-10B EVO

LB-50B EVO

Cat.No.	Number of blades in a case	QTY/ Inner carton	QTY/ Outer carton	N.W. (kgs)	G.W. (kgs)	M3	Carton size (Cm) D x W x H	EAN
LB-10B EVO	10	20	200	15	17	0.014	24 x 36 x 15.5	4954183 528409
LB-50B EVO	50	10	50	19	21	0.011	15 x 45 x 16.5	4954183 528416

**EVO DURABLE EDGE**

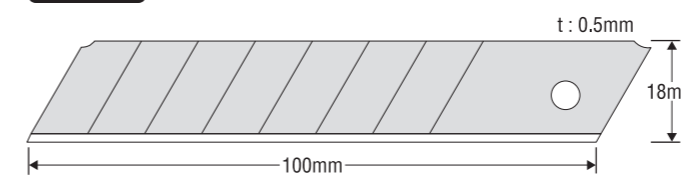

LB-10 EVO

LB-50 EVO

Cat.No.	Number of blades in a case	QTY/ Inner carton	QTY/ Outer carton	N.W. (kgs)	G.W. (kgs)	M3	Carton size (Cm) D x W x H	EAN
LB-10 EVO	10	20	200	15	17	0.014	24 x 36 x 15.5	4954183 528423
LB-50 EVO	50	10	50	19	21	0.011	15 x 45 x 16.5	4954183 528430

### 15 segments Blades

**EVO SHARP EDGE**

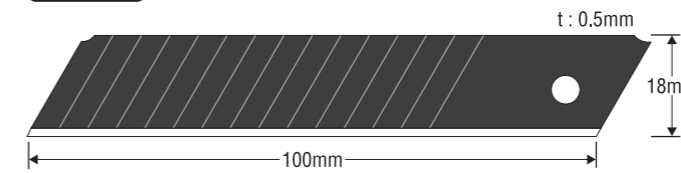

LB-10BW EVO

Cat.No.	Number of blades in a case	QTY/ Inner carton	QTY/ Outer carton	N.W. (kgs)	G.W. (kgs)	M3	Carton size (Cm) D x W x H	EAN
LB-10BW EVO	10	20	200	15	17	0.014	24 x 36 x 15.5	4954183 528294

**EVO DURABLE EDGE**

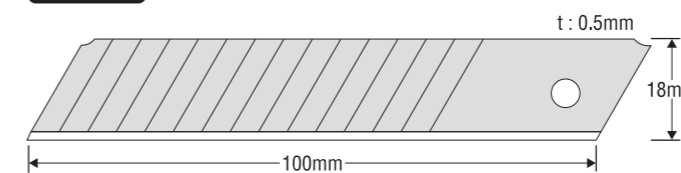

LB-10W EVO

LB-50W EVO

Cat.No.	Number of blades in a case	QTY/ Inner carton	QTY/ Outer carton	N.W. (kgs)	G.W. (kgs)	M3	Carton size (Cm) D x W x H	EAN
LB-10W EVO	10	20	200	15	17	0.014	24 x 36 x 15.5	4954183 528287
LB-50W EVO	50	10	50	19	21	0.011	15 x 45 x 16.5	4954183 528805

Spare Blades

Spare Blades

## Spare Blades

### L-Blades 18mm

#### Non-Snap Blades Solid blades, non-snap blades for special purpose

##### EVO SHARP EDGE

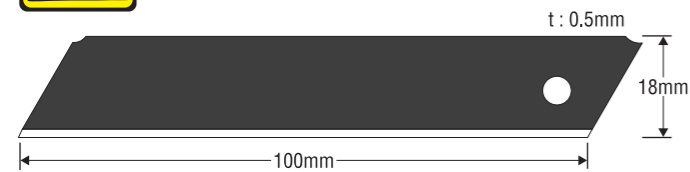

Cat.No.	Number of blades in a case	QTY/ Inner carton	QTY/ Outer carton	N.W. (kgs)	G.W. (kgs)	M3	Carton size (Cm) D x W x H	EAN
LB-10BNL EVO	10	20	200	15	17	0.014	24 x 36 x 15.5	4954183 524678
LB-50BNL EVO	50	10	50	19	21	0.011	15 x 45 x 16.5	4954183 524685

##### EVO DURABLE EDGE

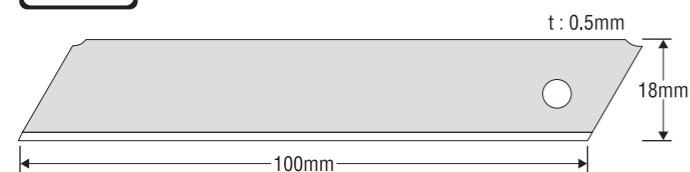

Cat.No.	Number of blades in a case	QTY/ Inner carton	QTY/ Outer carton	N.W. (kgs)	G.W. (kgs)	M3	Carton size (Cm) D x W x H	EAN
LB-10NL EVO	10	20	200	15	17	0.014	24 x 36 x 15.5	4954183 524692
LB-50NL EVO	50	10	50	19	21	0.011	15 x 45 x 16.5	4954183 524708

## Stainless steel Series

Perfect for wet environments

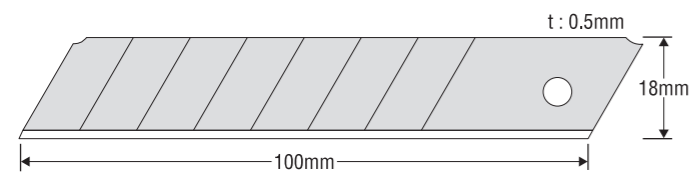

Cat.No.	Number of blades in a case	QTY/ Inner carton	QTY/ Outer carton	N.W. (kgs)	G.W. (kgs)	M3	Carton size (Cm) D x W x H	EAN
LB-10S EVO	10	20	200	15	17	0.014	24 x 36 x 15.5	4954183 564049

### Non-Snap L-blades

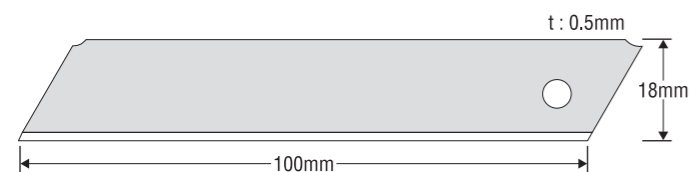

Cat.No.	Number of blades in a case	QTY/ Inner carton	QTY/ Outer carton	N.W. (kgs)	G.W. (kgs)	M3	Carton size (Cm) D x W x H	EAN
LB-10SNL EVO	10	20	200	19	21	0.014	24 x 35 x 15.5	4954183 565046

## Spare Blades

### S-Blades 9mm

##### EVO SHARP EDGE

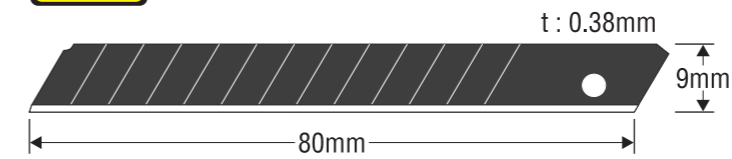

Cat.No.	Number of blades in a case	QTY/ Inner carton	QTY/ Outer carton	N.W. (kgs)	G.W. (kgs)	M3	Carton size (Cm) D x W x H	EAN
SB-10B EVO	10	20	200	5	7	0.007	16 x 31 x 14	4954183 524838
SB-50B EVO	50	10	50	18	20	0.004	9 x 33.5 x 13	4954183 524845

##### EVO DURABLE EDGE

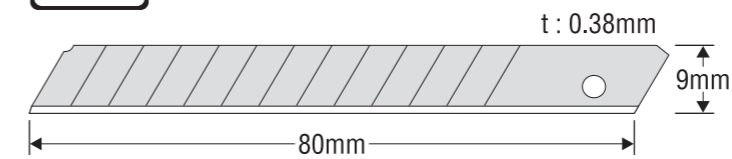

Cat.No.	Number of blades in a case	QTY/ Inner carton	QTY/ Outer carton	N.W. (kgs)	G.W. (kgs)	M3	Carton size (Cm) D x W x H	EAN
SB-10 EVO	10	20	200	5	7	0.007	16 x 31 x 14	4954183 524852
SB-50 EVO	50	10	50	18	20	0.004	9 x 33.5 x 13	4954183 524869

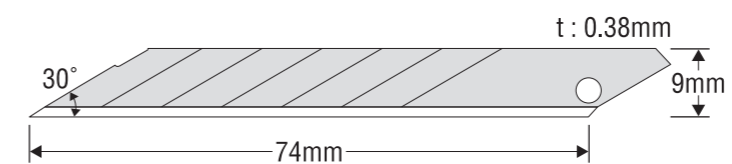

Application : S-18

Cat.No.	Number of blades in a case	QTY/ Inner carton	QTY/ Outer carton	N.W. (kgs)	G.W. (kgs)	M3	Carton size (Cm) D x W x H	EAN
VB-10 EVO	10	20	200	7	9	0.007	16 x 31 x 14	4954183 528478

#### Non-Snap Blades Solid blades, non-snap blades for special purpose

##### EVO SHARP EDGE



Cat.No.	Number of blades in a case	QTY/ Inner carton	QTY/ Outer carton	N.W. (kgs)	G.W. (kgs)	M3	Carton size (Cm) D x W x H	EAN
SB-10BNL EVO	10	20	200	5	7	0.007	16 x 31 x 14	4954183 528300
SB-50BNL EVO	50	10	50	18	20	0.004	9 x 33.5 x 13	4954183 528317

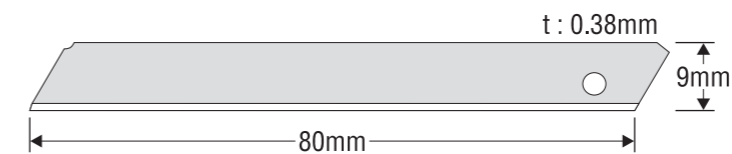

Cat.No.	Number of blades in a case	QTY/ Inner carton	QTY/ Outer carton	N.W. (kgs)	G.W. (kgs)	M3	Carton size (Cm) D x W x H	EAN
SB-10NL EVO	10	20	200	5	7	0.007	16 x 31 x 14	4954183 528485
SB-50NL EVO	50	10	50	18	20	0.004	9 x 33.5 x 13	4954183 530129

# Spare Blades

## Saws

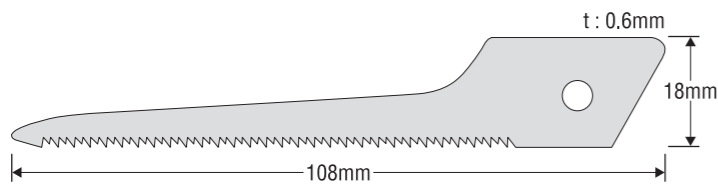

HSB-W

Application : T-11

Cat.No.	Number of blades in a case	QTY/ Inner carton	QTY/ Outer carton	N.W. (kgs)	G.W. (kgs)	M3	Carton size (Cm) D x W x H	EAN
HSB-W	1	10	100	3	4	0.022	33 x 36 x 18.5	4954183 516826

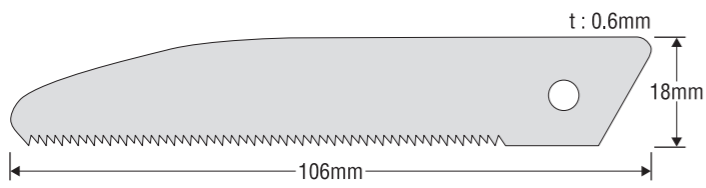

HSB-Z

Application : T-11

Cat.No.	Number of blades in a case	QTY/ Inner carton	QTY/ Outer carton	N.W. (kgs)	G.W. (kgs)	M3	Carton size (Cm) D x W x H	EAN
HSB-Z	1	10	100	3	4	0.022	33 x 36 x 18.5	4954183 516819

## Hook

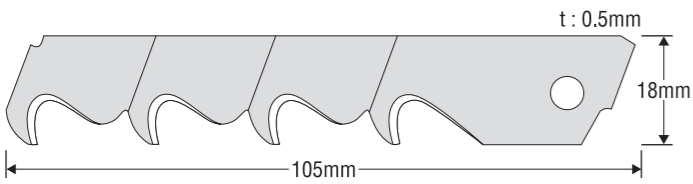

HK-5 EVO

Application : HK-11

Made in Solingen, Germany

Cat.No.	Number of blades in a case	QTY/ Inner carton	QTY/ Outer carton	N.W. (kgs)	G.W. (kgs)	M3	Carton size (Cm) D x W x H	EAN
HK-5 EVO	5	20	200	11	13	0.014	24 x 36 x 15.5	4954183 524777

## Others

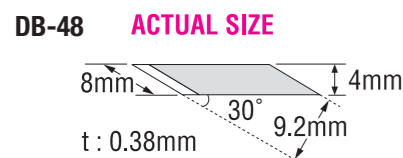

Application : D-12

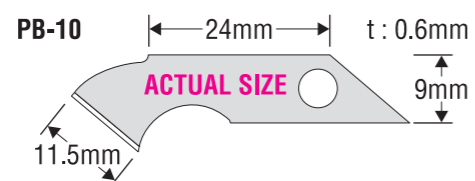

Application : P-11

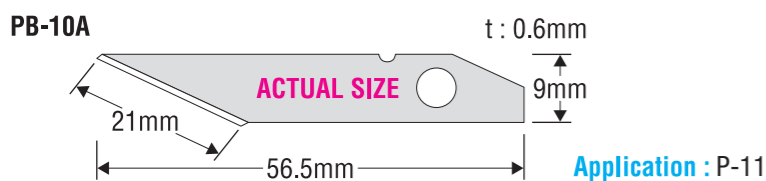

Application : P-11



PB-10A

PB-10

Cat.No.	Number of blades in a case	QTY/ Inner carton	QTY/ Outer carton	N.W. (kgs)	G.W. (kgs)	M3	Carton size (Cm) D x W x H	EAN
DB-48	48	10	100	8	10	0.022	33 x 36 x 18.5	4954183 542832
PB-10	10	10	100	4	6	0.022	33 x 36 x 18.5	4954183 542818
PB-10A	10	10	100	4	6	0.022	33 x 36 x 18.5	4954183 542825

# KDS The Pro's Quality Choice

### Power Black Evolution



1 HB-5B EVO 2 HB-10B EVO 6 GB-10B EVO 10 GB-50B EVO



13 LB-10B EVO 22 LB-50B EVO 27 SB-10B EVO 32 SB-50B EVO

### Power White Evolution



3 HB-10 EVO 7 GB-10 EVO 11 GB-50 EVO 14 LB-10 EVO



23 LB-50 EVO 28 SB-10 EVO 33 SB-50 EVO 29 VB-10 EVO

### Non-Snap series



4 HB-10BNL EVO 17 LB-10BNL EVO 30 SB-10BNL EVO



9 GB-10NL EVO 20 LB-10SNL EVO



5 HB-10NL EVO 18 LB-10NL EVO 31 SB-10NL EVO

### 15 segments series



8 GB-10W EVO 15 LB-10BW EVO 16 LB-10W EVO 24 LB-50W EVO

### Stainless steel series



19 LB-10S EVO

### Oil Free series



12 GB-50WOF EVO

### Trapezoidal series



38 TB-5B 39 TB-50B













### Others



21 HK-5 EVO 36 HSB-W 37 HSB-Z 42 PB-10A 41 PB-10

Spare Blades

## Spare Blades packaging

No.	Cat.No.	Number of blades in a case	QTY/Inner carton 	QTY/Outer carton 			
<b>25mm</b>							
1	HB-5B EVO	5		10			
2	HB-10B EVO	10					
3	HB-10 EVO						
4	HB-10BNL EVO						
5	HB-10NL EVO						
<b>G-18mm</b>							
6	GB-10B EVO	10		20			
7	GB-10 EVO						
8	GB-10W EVO						
9	GB-10NL EVO						
10	GB-50B EVO	50		10			
11	GB-50 EVO						
12	GB-50WOF EVO						
<b>18mm</b>							
13	LB-10B EVO	10		20			
14	LB-10 EVO						
15	LB-10BW EVO						
16	LB-10W EVO						
17	LB-10BNL EVO						
18	LB-10NL EVO						
19	LB-10S EVO						
20	LB-10SNL EVO						
21	HK-5 EVO				5		10
22	LB-50B EVO				50		
23	LB-50 EVO						
24	LB-50W EVO						
25	LB-50BNL EVO						
26	LB-50NL EVO						
<b>9mm</b>							
27	SB-10B EVO	10		20			
28	SB-10 EVO						
29	VB-10 EVO						
30	SB-10BNL EVO						
31	SB-10NL EVO						
32	SB-50B EVO	50		10			
33	SB-50 EVO						
34	SB-50BNL EVO						
35	SB-50NL EVO						
<b>Saws</b>							
36	HSB-W	1		10			
37	HSB-Z						
<b>Trapezoidal series</b>							
38	TB-5B	5		20			
39	TB-50B	50		8			
<b>Others</b>							
40	DB-48	48		10			
41	PB-10	10					
42	PB-10A						

## Safety-Bases

### Safety-Bases e

Concern for our planet  
Non-toxic if incinerated.  
Made of Olefin resin.

From easy-to-use day-timer size to large desk size, choose the one that's best for you.

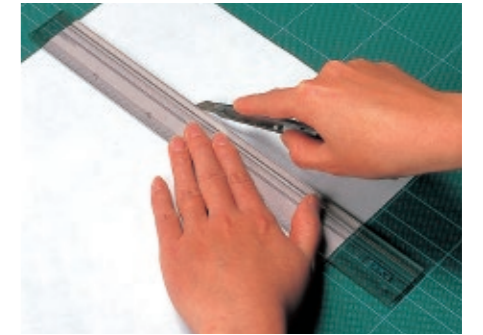
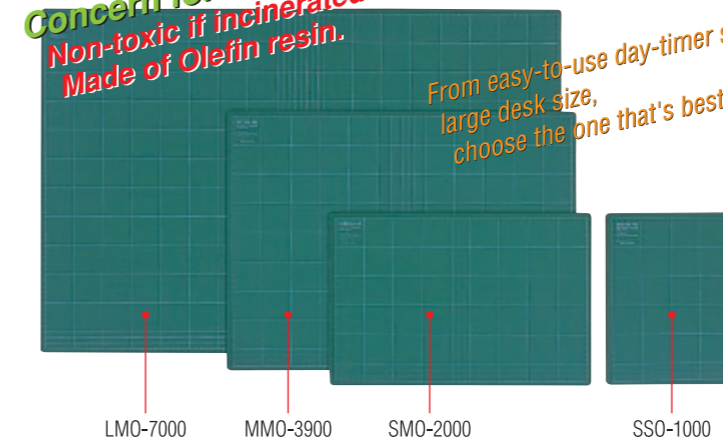

Takes an edge softly, keeps the media from slipping, protects your desk or table from scratches, and makes cutting safe.

#### Three environmental-E!

Use both sides! Lasts twice as long!

Made of Olefin resin. Rigid and lightweight. Efficient, 5mm grid lines.

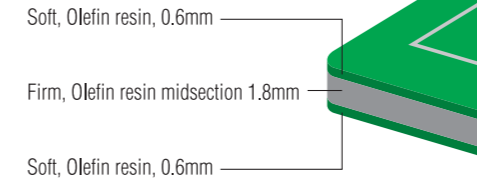

Cat.No.	Size(mm)	QTY/Inner carton	QTY/Outer carton	N.W. (kgs)	G.W. (kgs)	M3
<b>Easy-eye Green</b>						
SSO-1000	300 x 220 x 3	10	80	24	26	0.045
SMO-2000	450 x 300 x 3		40			
MMO-3900	620 x 450 x 3		20	23	25	0.085
LMO-7000	600 x 900 x 3		10			0.045

## Scissors

### Stainless Steel Scissors



KSC-1

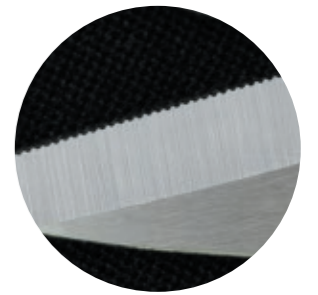

Recommended for professionals as well as DIY users.  
Stainless steel blades and secure hinge for heavy-duty tasks.  
Non-slip serrated blades assure safe and smooth cutting.



KSC-2



Carton



Box



KSC-1



KSC-2

Cat.No.	Color	Size	QTY/Inner carton	QTY/Outer carton	N.W. (kgs)	G.W. (kgs)	M3	Carton size (cm) D x W x H	EAN
KSC-1	Yellow	5-1/2" / 140mm	12	96	7	9	0.027	26 x 43 x 24	4954183 561901
KSC-2		6-1/2" / 165mm			8	10			4954183 527761

# GG Scraper



Recommended for removal of various materials, including wallpaper and tile, paint, gaskets, adhesives, and floor coverings.

- 1) Fluoroplastic-coated head prevents sticking and allows for easy cleaning.
- 2) No need for screwdrivers or coins, the thumb-locking screws keep the blade tight.
- 3) Three lengths to suit the specific job.



With 5 non-snap blades

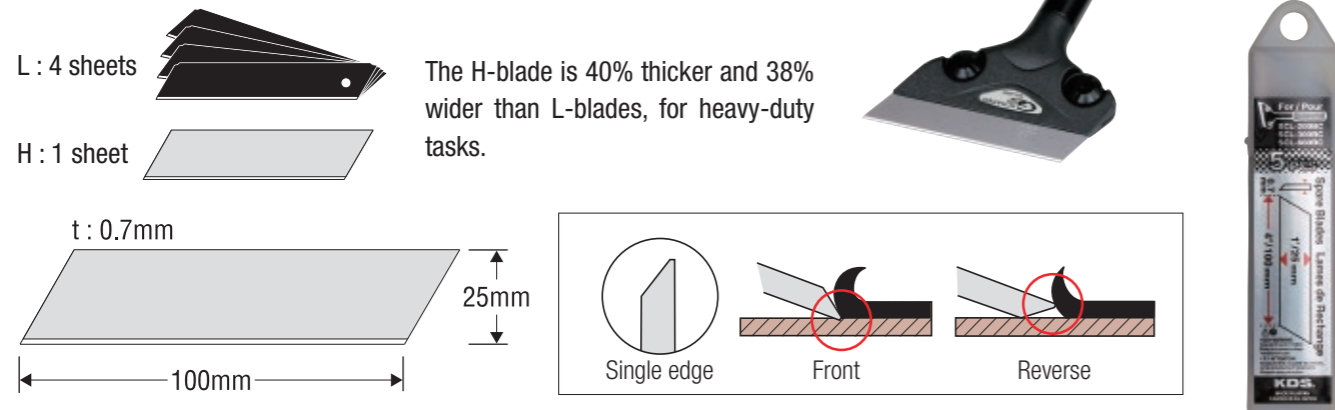

The H-blade is 40% thicker and 38% wider than L-blades, for heavy-duty tasks.

\* H-type is dedicated blades for GG Scraper series.

Cat. No.	Description	Size	QTY/ Inner carton	QTY/ Outer carton	N.W. (kgs)	G.W. (kgs)	M3	Carton size (Cm) D x W x H	EAN
SCL-200BC	Come with a BLADE COVER and 5 non-snap blades	200mm	4	24	10	12	0.058	56 x 34 x 30	4954183 525538
SCL-300BC		300mm			13	15	0.070	56 x 43 x 30	4954183 525545
SCL-600BC		600mm			15	17	0.124	74 x 57 x 30	4954183 525552
LB-10BNL EVO	10 blades in a pla. case	L-type (t:0.5mm)	20	200	15	17	0.014	24 x 36 x 15.5	4954183 524678
HB-5SCL	5 blades in a pla. case	H-type (t:0.7mm)			100	8	10	0.011	15 x 45 x 16.5

# Stainless steel putty knives



Co-mold non-slip rubber grip and 4 screw bits in the handle. Hardened and tempered stainless steel blade.

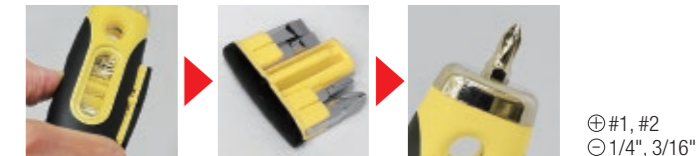

Flexible type



JAPANESE PACKAGE ONLY

Chisel type



14-in-1 type



- SC-M76SD:
- 1 : Scraping
  - 2 : Spreading
  - 3 : Opening paint cans
  - 4 : Cleaning out cracks
  - 5 : Pulling nails
  - 6 : Cleaning paint rollers
  - 7 : Scraping convex
  - 8 : Opening bottle caps
  - 9 : Scraping concave
  - 10 : Setting nails
  - 11-14 : Screw drivers
- ⊕ : #1, #2   ⊖ : 1/4", 3/16"

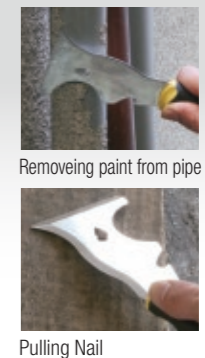

Removing paint from pipe

Pulling Nail

	Cat.No.	Type	Width	QTY/ Inner carton	QTY/ Outer carton	N.W. (kgs)	G.W. (kgs)	M3	Carton size (Cm) D x W x H	EAN
①	SC-F76SD	Flexible	3" / 76mm	12	72	10	12	0.034	27 x 59 x 21	4954183 525170
②	SC-F102SD		4" / 102mm			11	13			4954183 525187
③	SC-F127SD		5" / 127mm			12	14			4954183 525194
④	SC-F152SD		6" / 152mm							4954183 525200
⑤	SC-C38SD	Chisel	1-1/2" / 38mm	11	13	10	12	0.034	27 x 59 x 21	4954183 525132
⑥	SC-C51SD		2" / 51mm							-
⑦	SC-C76SD		3" / 76mm							4954183 530181
⑧	SC-M76SD	Chisel 14-in-1	3" / 76mm							4954183 530174



# GG saw

**GG SAW** ~Ideal for cutting PVC & WOOD~

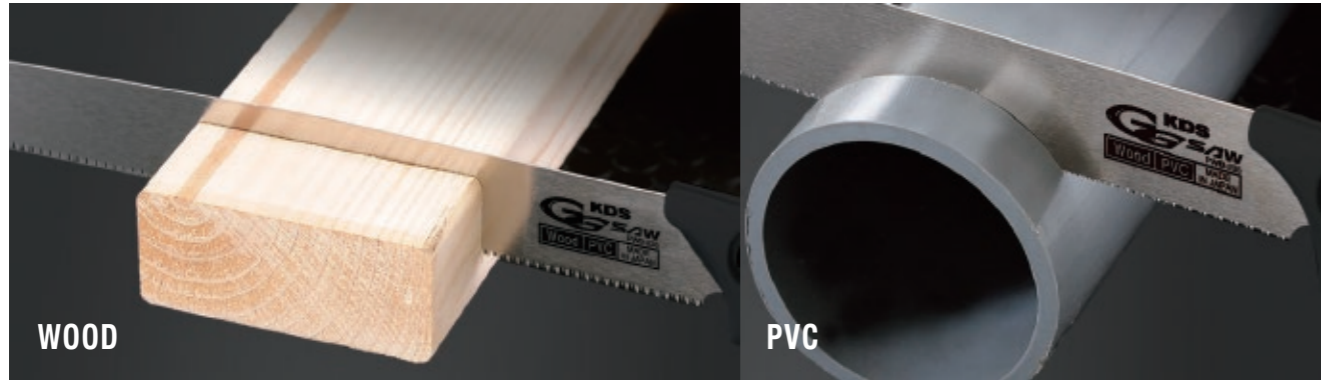

Ergonomic pull saw with exchangeable standard thin-cerf blade. Excellent for cutting general materials such as wood, PVC, and insulation board. The handle can also accept KDS keyhole and hack-type replacement blades.



### Grip fit handle

Molded, non-slip cushioned comfort rubber grip.

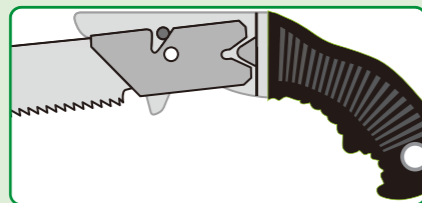
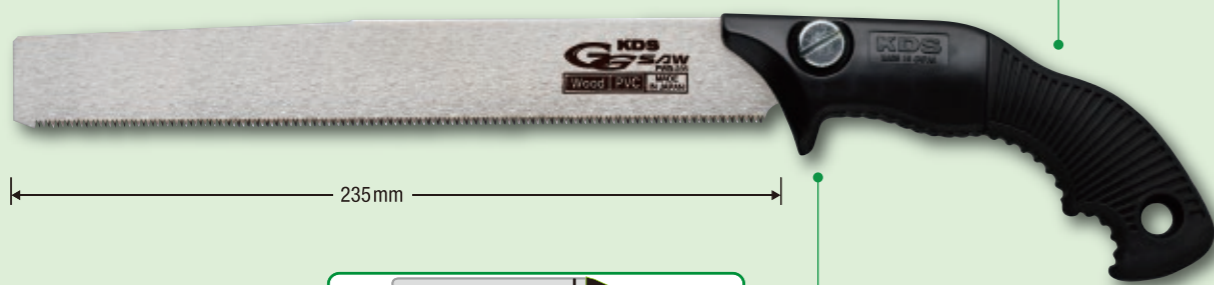

### Unique blade

Reinforced blade mount.



PW-235



PWB-235

### Maximum cutting size

PVC/PE pipe	100mm φ
Plastic plate	t: 10mm
Wood	t: 50mm

### Specifications

Metal	SK95 (SK4) High carbon steel
Blade length	235mm
Thickness	0.7mm
TPI (Teeth Per Inch)	20
Kerf	1.0mm (±0.05mm)

Cat.No.	QTY/ Inner carton	QTY/ Outer carton	N.W. (kgs)	G.W. (kgs)	M3	Carton size (Cm) D x W x H	EAN
PW-235	10	60	9	10	0.030	39 x 44 x 17	4954183 531119
PWB-235	10	100	11	12	0.020	35 x 28 x 20	4954183 531126

# GG saw

## GG Saw Metal / PVC

**NEW**

Ergonomic pull saw with exchangeable hack-type thin-cerf blade, primarily for cutting metal and other rigid materials. The handle can also accept KDS keyhole and standard replacement blades.



PM-235



PMB-235



Cat.No.	QTY/ Inner carton	QTY/ Outer carton	N.W. (kgs)	G.W. (kgs)	M3	Carton size (Cm) D x W x H	EAN
PM-235	10	60	9	10	0.030	39 x 44 x 17	4954183 565671
PMB-235	10	100	11	12	0.020	35 x 28 x 20	4954183 565688

## GG Saw Keyhole

**NEW**

Ergonomic pull saw with exchangeable keyhole-type thin-cerf blade. Ideal for curved or drywall cuts. The handle can also accept KDS metal hack and standard replacement blades.



KH-188

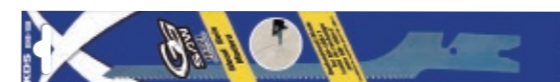

KHB-188



Cat.No.	QTY/ Inner carton	QTY/ Outer carton	N.W. (kgs)	G.W. (kgs)	M3	Carton size (Cm) D x W x H	EAN
KH-188	10	60	8	9	0.030	39 x 44 x 17	4954183 565695
KHB-188	10	50	4	5	0.015	35 x 28 x 15	4954183 565701

# Pocket Tapes



Durable Nylon Coat  
10x friction resistance

Friction resistance comparison

KDS nylon coat (approx. 10,000 times) Typical coat (approx. 1,000 times)



High Strength  
Thick Hook

1.5 times thicker  
**2.5 times stronger**

than KDS standard hook

Reduces bent hook risk

For a good grip

**GGR**  
GOOD GRIP REVOLUTION

**NEW** New pocket tapes series debut!!

Ergonomic rubberized cover for confident grip

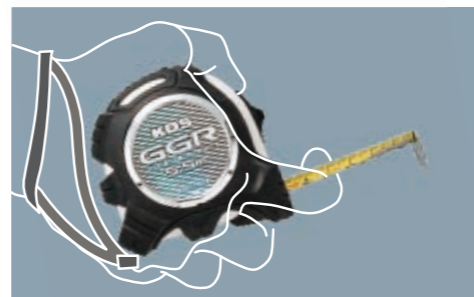

	Cat.No.	Length	Width
EU	GGR16-35EUB	3.5m	16mm
	GGR25-55EUB	5.5m	25mm
	GGR25-75EUB	7.5m	
ME	GGR25-55YMEB	5.5m x 18ft.	25mm
	GGR25-75YMEB	7.5m x 25ft.	

# Coatings



Nylon Coat

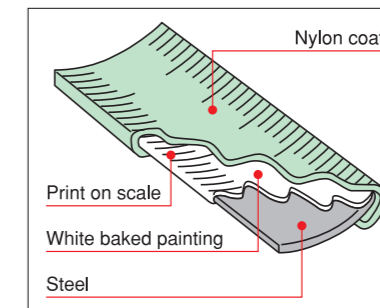

**10 times** more durable than Acrylic coating but case size as compact as Acrylic.



**KDS Standard**

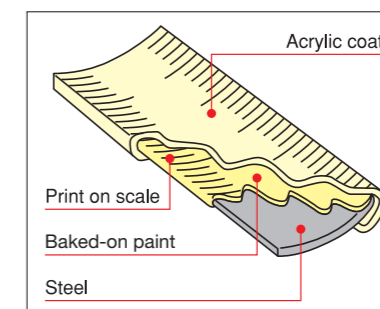

Double-Faced Scale

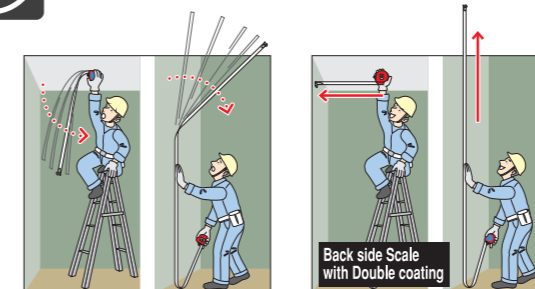

Strong 4rivets

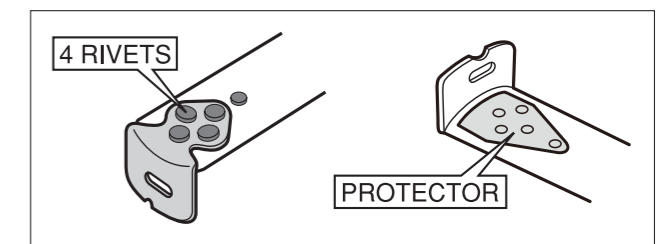

# Pocket Tapes Double-faced Scale

## GGEVO 19



New ergonomic design case.  
The nylon-coated blade is **10 times more durable** than KDS original acrylic coating.  
Non-slip rubberized grip fits your palm and protects the case from damage.  
Hook protector protects end-hook.  
The tape itself has scales on both sides to easily measure heights, and comes with a strong, 4-rivet diamond-pattern hook.



	Cat.No.	Length	Width	QTY/ Inner carton	QTY/ Outer carton	N.W. (kgs)	G.W. (kgs)	M3	Carton size (cm) D x W x H
EU	GGEVO19-55EU	5.5m	19mm	4	40	12	14	0.045	22 x 65 x 32



## GGEVO 25



New ergonomic design case.  
The nylon-coated blade is **10 times more durable** than KDS original acrylic coating.\*  
Non-slip rubberized grip fits your palm and protects the case from damage.  
Hook protector protects end-hook.  
The tape itself has scales on both sides to easily measure heights, and comes with a strong, 4-rivet diamond-pattern hook.

\*Except GGEVO25-10 series.



	Cat.No.	Length	Width	QTY/ Inner carton	QTY/ Outer carton	N.W. (kgs)	G.W. (kgs)	M3	Carton size (cm) D x W x H	
EU	GGEVO25-55EU	5.5m	25mm	4	40	16	18	0.045	22 x 65 x 32	
	GGEVO25-75EU	7.5m				20	22		0.050	24 x 65 x 32
	GGEVO25-10EU	10m				24	26			

# Pocket Tapes Double-Faced Scale

## GTR-2550



GTR-G2550 (with gum)

Thick hook : 1.5 times thicker than the KDS standard hook.  
Thick tape: New solid tape blade for more stand out than KDS "ZS series".  
New gum cover for more fitting to the Human palm.

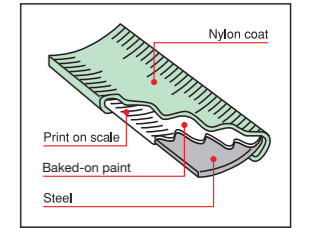
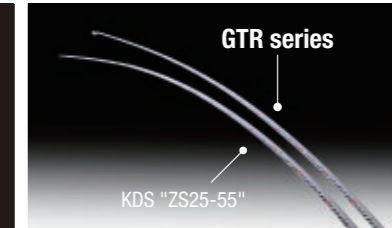

Cat.No.	Length	Width	QTY/ Inner carton	QTY/ Outer carton
GTR-G2550WEU BP	5m	25mm	4	40

## Both side Print 19



The KDS Double-lock leads the way in measuring tape development. Featuring a unique double-lock system, pulling up on the locking tab applies an easy rewind brake, while pushing down engages the full lock. The round design fits nicely in the palm. The tape itself has scales on both side to easily measure heights, and comes with a strong, diamond-pattern hook.  
4-rivet diamond-pattern hook.



	Cat.No.	Length	Width	QTY/ Inner carton	QTY/ Outer carton	N.W. (kgs)	G.W. (kgs)	M3	Carton size (cm) D x W x H
ME	ZS19-75YMEB BP	7.5m x 25ft.	19mm	6	60	18	20	0.035	20 x 61 x 29

## ZS 25



The KDS Double-lock leads the way in measuring tape development. Featuring a unique double-lock system, pulling up on the locking tab applies an easy rewind brake, while pushing down engages the full lock. The round design fits nicely in the palm. The tape itself comes with a strong, 4-rivet diamond-pattern hook.



	Cat.No.	Length	Width	QTY/ Inner carton	QTY/ Outer carton	N.W. (kgs)	G.W. (kgs)	M3	Carton size (cm) D x W x H	
EU	ZS25-55EUB BP	5.5m	25mm	4	40	11	13	0.035	20 x 61 x 29	
	ZS25-80EUB BP	8m				16	18		0.030	23 x 63 x 21
	ZS25-10EUB BP	10m				22	24			
ME	ZS25-60YMEB BP	6m x 20ft.	25mm	4	48	11	13	0.035	20 x 61 x 29	
	ZS25-80YMEB BP	8m x 26ft.				16	18		0.030	23 x 63 x 21
	ZS25-10YMEB BP	10m x 33ft.				22	24			

# Pocket Tapes Single-Faced Scale

## Jumbo 19



Heavy duty traditional model for professionals. The on-off, switching lock button locks the tape in any position at any point.



	Cat.No.	Length	Width	QTY/ Inner carton	QTY/ Outer carton	N.W. (kgs)	G.W. (kgs)	M3	Carton size (cm) D x W x H
EU	JM19-35WEUB CD	3.5m	19mm	6	60	12	14	0.035	34 x 56 x 18
	JM19-55WEUB CD	5.5m				15	17		



## Giant 25



Heavy duty traditional model for professionals. The on-off, switching lock button locks the tape in any position at any point.



	Cat.No.	Length	Width	QTY/ Inner carton	QTY/ Outer carton	N.W. (kgs)	G.W. (kgs)	M3	Carton size (cm) D x W x H
EU	GT25-55WEUB CD	5.5m	25mm	4	32	10	12	0.032	39 x 27 x 30
	GT25-75WEUB CD	7.5m				13	14		
ME	GT25-60YMEB BP	6m x 20ft.	25mm	6	60	20	22	0.047	23 x 65 x 32
	GT25-80YMEB BP	8m x 26ft.				25	27		



## PRONEXT 25



A new generation of pocket tapes for every use! The ergonomically designed case fits perfectly in your palm and the hook protector protects against accidental drops. Four color variations (black, yellow, red, blue) in an attractive counter display box.

	Cat.No.	Length	Width	QTY/ Inner carton	QTY/ Outer carton	N.W. (kgs)	G.W. (kgs)	M3	Carton size (Cm) D x W x H
EU	PX25-55EUB DB	5.5m	25mm	12pcs. In POP carton box	24	7	8	0.017	30 x 49 x 12



# Pocket Tapes Single-Faced Scale

## New NeoLock 13/16



Compact, lightweight pocket tape with brake.



	Cat.No.	Length	Width	QTY/ Inner carton	QTY/ Outer carton	N.W. (kgs)	G.W. (kgs)	M3	Carton size (cm) D x W x H
EU	S16-35NEUB BP	3.5m	16mm	6	120	18	20	0.064	40 x 57 x 28
	S16-55NEUB BP	5.5m				24	26		
ME	S16-50NYMEB BP	5m x 16ft.	13mm	6	60	10	12	0.064	40 x 57 x 28
	NS1320 WMBH BPLC	2m				18	20		
JIS	NS1635 WMBH BPLC	3.5m	16mm	6	60	18	20	0.064	40 x 57 x 28
	NS1655 WMBH BPLC	5.5m				24	26		

## NeoLock 16



The on-off, switching lock button locks the tape in position at any point and also controls retraction into the case.



	Cat.No.	Length	Width	QTY/ Inner carton	QTY/ Outer carton	N.W. (kgs)	G.W. (kgs)	M3	Carton size (cm) D x W x H
ME	KS16-50YMEB BP	5m x 16ft.	16mm	6	120	29	31	0.064	40 x 57 x 28

## NeoLock 19



A sturdy lock button locks the tape in any position and retracts the tape smoothly into the case. Rugged diamond-pattern (4-rivet) hook tip.



	Cat.No.	Length	Width	QTY/ Inner carton	QTY/ Outer carton	N.W. (kgs)	G.W. (kgs)	M3	Carton size (Cm) D x W x H
ME	KS19-55YMEB BP	5.5m x 18ft.	19mm	6	60	15	17	0.032	20 x 62 x 26

# Pocket Tapes With push-pull type

## Free 13/16



Compact size pocket tape with smooth contoured line, the case fits comfortably in the hand. Most popular in the stationery and DIY fields. **Without belt-clip.**

	Cat.No.	Length	Width	QTY/ Inner carton	QTY/ Outer carton	N.W. (kgs)	G.W. (kgs)	M3	Carton size (Cm) D x W x H
JIS	KF1320 WM BP	2m	13mm	6	120	8	10	0.025	30 x 42 x 20
	KF1635 WM BP	3.5m	16mm		60	7	9	0.016	16 x 50 x 20
	KF1655 WM BP	5.5m				11	13	0.019	18 x 49 x 21



## Compact Free 19



Compact size pocket tape **with convenient stop button and belt-clip.** Rugged diamond-pattern (4-revet) hook tip

	Cat.No.	Length	Width	QTY/ Inner carton	QTY/ Outer carton	N.W. (kgs)	G.W. (kgs)	M3	Carton size (Cm) D x W x H
JIS	CF1935 WMBH BP	3.5m	19mm	6	60	13	15	0.035	20 x 61 x 29
	CF1955 WMBH BP	5.5m				15	17		
	CF1975 WMBH BP	7.5m				18	20		



## Steel Diameter Tape

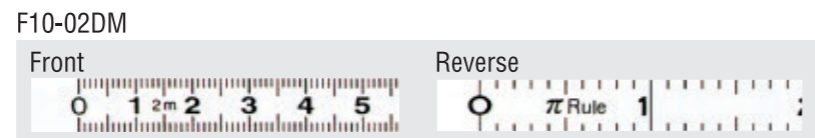

Cat.No.	Length	Width	QTY/ Inner carton	QTY/ Outer carton	N.W. (kgs)	G.W. (kgs)	M3	Carton size (Cm) D x W x H
F10-02DM	2m	10mm	12	120	8	10	0.011	25 x 32 x 13
F10-02EP	64ths			240	14	16	0.017	21 x 41 x 19
F10-02EPD	100ths							

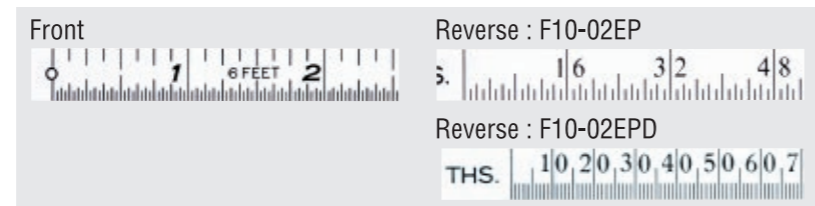

Diameter rules provide accuracy in an ordinary linear measurement plus diameter measurement.

## Steel Flat Tape

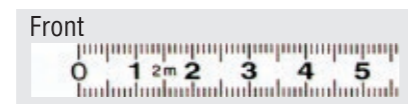

KDS flat rules are most useful in machinery or textile applications.

Cat.No.	Length	Width	QTY/ Inner carton	QTY/ Outer carton	N.W. (kgs)	G.W. (kgs)	M3	Carton size (Cm) D x W x H
F10-02	2m	10m	12	240	14	16	0.017	21 x 41 x 19

# Pocket Tapes

## Mini-Rod

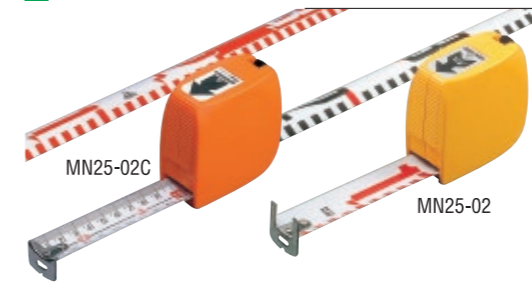

Mini-Rods are extremely useful for taking close-up photo records and for survey work, having two distinct 5mm graduations, one on each side of the tape.

Cat.No.	Length	Width	QTY/ Inner carton	QTY/ Outer carton	N.W. (kgs)	G.W. (kgs)	M3	Carton size (Cm) D x W x H
MN25-02	2m Rod	25mm	10	50	6	8	0.017	21 x 41 x 19
MN25-02C	2m + 2m Rod							

## Setting Measure

Reverse graduation also available



Stick-on steel tape measure with self-adhesive back. Use as customized measure for workbenches, saw tables machinery, desks, countertops, poles, walls, columns, etc.

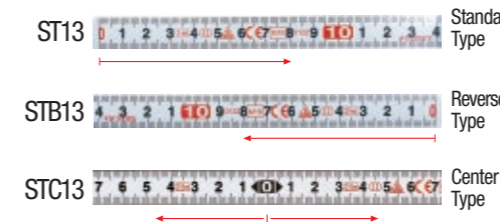







Cat.No.	Length	Width	QTY/ Inner carton	QTY/ Outer carton	N.W. (kgs)	G.W. (kgs)	M3	Carton size (Cm) D x W x H
ST13	Standard Type	13mm	10	60	2.2	2.7	0.024	49 x 33 x 15
ST13-01EU BP	1m CE mark							
ST13-02EU BP	2m CE mark							
ST13-05EU BP	5m CE mark							
STB13	Reversed Type							
STB13-01EU BP	1m CE mark							
STB13-02EU BP	2m CE mark							
STB13-05EU BP	5m CE mark							
STC13	Center Type							
STC13-05EU BP	2.5m+2.5m CE mark							
ST13-05ME BP	5m x 16ft.							











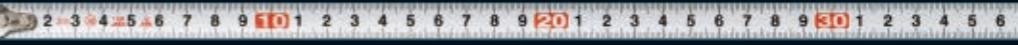
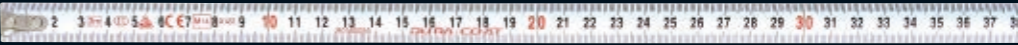

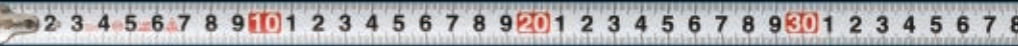

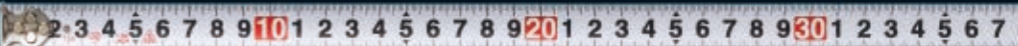
## Pocket Tapes packaging-1

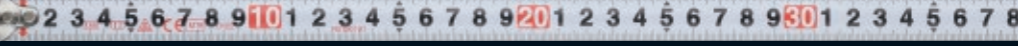
Name	Graduation	Cat. No.	Length	Width	QTY/ Inner carton	QTY/ Outer carton	
GGEVO 19/25	EU	GGEVO19-55EU	5.5m	19mm	4	40	
	EU	GGEVO25-55EU					
	EU	GGEVO25-75EU	7.5m	25mm			
	EU	GGEVO25-10EU	10m	25mm			
GTR 25	EU	GTR-G2550WEU BP	5m	25mm	4	Packed 10 inner cartons	
Both side Print 19 ZS 25	ME	ZS19-75YMEB BP	7.5m x 25ft.	19mm	6	60	
	EU	ZS25-55EUB BP	5.5m	25mm	4	40	
		ZS25-80EUB BP	8m				
		ZS25-10EUB BP	10m				
	ME	ZS25-60YMEB BP	6m x 20ft.	25mm	4	Packed 12 inner cartons	48
		ZS25-80YMEB BP	8m x 26ft.				
ZS25-10YMEB BP	10m x 33ft.						
Jumbo 19 Giant 25	EU	JM19-35WEUB CD	3.5m	19mm	6	Packed 10 inner cartons	60
		JM19-55WEUB CD	5.5m	25mm	4	Packed 8 inner cartons	32
		GT25-55WEUB CD	7.5m				
	ME	GT25-60YMEB BP	6m x 20ft.	25mm	6	Packed 10 inner cartons	60
		GT25-80YMEB BP	8m x 26ft.				

## Pocket Tapes packaging-2

Name	Graduation	Cat. No.	Length	Width	QTY/ Inner carton	QTY/ Outer carton
PRONEXT 25	EU	PX25-55EUB DB	5.5m	25mm		12
New NeoLock 13/16	EU	S16-35NEUB BP	3.5m	16mm		6
	EU	S16-55NEUB BP	5.5m			
	ME	S16-50NYMEB BP	5m x 16ft.			
	JIS	NS1320 WMBH BPLC	2m	13mm		
		NS1635 WMBH BPLC	3.5m			
NS1655 WMBH BPLC		5.5m				
NeoLock 16	ME	KS16-50YMEB BP	5m x 16ft.	16mm		
NeoLock 19	ME	KS19-55YMEB BP	5.5m x 18ft.	19mm		
Free 13/16	JIS	KF1320 WM BP	2m	13mm		6
		KF1635 WM BP	3.5m			
		KF1655 WM BP	5.5m			
Compact Free19	JIS	CF1935 WMBH BP	3.5m	19mm		6
		CF1955 WMBH BP	5.5m			
		CF1975 WMBH BP	7.5m			
Steel Diameter tape		F10-02DM	2m	10mm		12
		F10-02EP	64ths			
		F10-02EPD	100ths			
		F10-02	2m			
Mini-Rod		MN25-02	2m Rod	25mm		10
		MN25-02C	2m+2m Rod			
Setting Measure		ST13-01EU BP	1m CEmark	13mm		10
		ST13-02EU BP	2m CEmark			
		ST13-05EU BP	5m CE mark			
		STB13-01UE BP	1m CEmark			
		STB13-02EU BP	2m CEmark			
		STB13-05EU BP	5m CE mark			
		STC13-05EU BP	2m+2m CEmark			
ST13-05ME BP	5m x 18ft.					

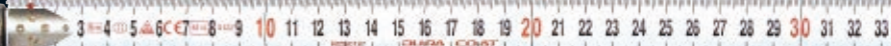
## Pocket Tapes Marking specifications and graduations

13mm wide	JIS	
	EU	
16mm 5/8 inch wide	ME	
	JIS	
19mm 3/4 inch wide	ME	
	JIS	
25mm 1 inch wide	EU	
	ME	
19mm wide	JM19-35WEU	
25mm wide	GT25-75WEU	
<b>Double faced Tape</b>		
16mm 5/8 inch wide	EU	Front Side  Back Side 
	EU	Front Side  Back Side 
19mm 3/4 inch wide	EU	Front Side  Back Side 
	ME	Front Side  Back Side 
25mm 1 inch wide		

# Long Tapes

## SPEED TECRON®

**4x Super rewind** 1wind-up,4rewinding

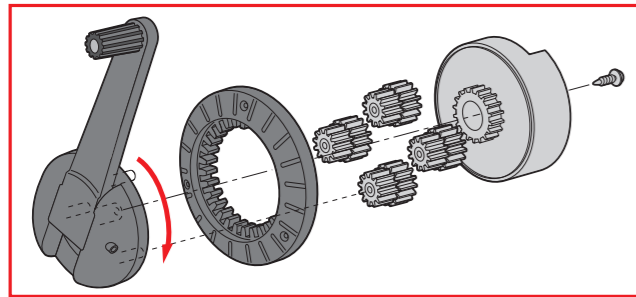

Drop-shock resistant elastomer tip



Slip resistant elastomer grip

## Speed Tecron-10 "4x Super rewind" Nylon coating stainless steel long tapes

### Stainless Steel

Quad-Speed rewind, extruded nylon coated stainless steel long tape. Easy to read black and red marking with quick reading meter figures. Standard tension:20°C 50N [Tape thickness: 0.4mm]

	Cat.No.	Length	Width	QTY/ Inner carton	QTY/ Outer carton	N.W. (kgs)	G.W. (kgs)	M3	Carton size (Cm) D x W x H
JIS	SST10-30	30m	10mm	1	5	5	7	0.022	30 x 31 x 23
	SST10-50	50m				6	8	0.027	30 x 35 x 26

※ White tape and metric graduation only



## Speed Tecron-13 "4x Super rewind" Nylon coating steel long tapes

With the Quad-Speed Tecron, turn the handle once and the tape rewinds four times!

And the nylon coating on the tape blades means it's waterproof. 10mm wide tape is also available. Standard tension:20°C 100N [Tape thickness: 0.45mm]

	Cat.No.	Length	Width	QTY/ Inner carton	QTY/ Outer carton	N.W. (kgs)	G.W. (kgs)	M3	Carton size (Cm) D x W x H
JIS	ST13-30	30m	13mm	1	5	7	9	0.022	30 x 31 x 23
	ST13-50	50m				10	12	0.027	30 x 35 x 26



# Long Tapes

## Tecron-13

Nylon coating steel long tapes

Multi-purpose, easy to use, Nylon coating long steel measuring tapes. Standard tension:20°C 100N [Tape thickness: 0.45mm]

	Cat.No.	Length	Width	QTY/ Inner carton	QTY/ Outer carton	N.W. (kgs)	G.W. (kgs)	M3	Carton size (Cm) D x W x H
JIS	TL13-30	30m	13mm	1	5	6	8	0.022	30 x 31 x 23
	TL13-50	50m				8	10	0.027	30 x 35 x 26



## Unilong-13

Steel long tapes

Unilong tapes are made from hardened and tempered high-carbon steel which has been treated with phosphate to protect against rust and corrosion. Standard tension:20°C 100N [Tape thickness: 0.23mm]

	Cat.No.	Length	Width	QTY/ Inner carton	QTY/ Outer carton	N.W. (kgs)	G.W. (kgs)	M3	Carton size (Cm) D x W x H
JIS	UL13-30	30m	13mm	1	5	6	8	0.022	30 x 31 x 23
	UL13-50	50m				8	10	0.027	30 x 35 x 26



## Kaclong-10

Steel long tapes

Economical type of long tape, in an ABS plastic case, and equipped with vinyl wrist strap.

Standard tension:20°C 20N [Tape thickness: 0.18mm]

	Cat.No.	Length	Width	QTY/ Inner carton	QTY/ Outer carton	N.W. (kgs)	G.W. (kgs)	M3	Carton size (Cm) D x W x H
JIS	KL10-10	10m	10mm	6	24	5	7	0.016	24 x 56 x 12
	KL10-20	20m				7	9	0.022	29 x 63 x 12
	KL10-30	30m				12	14	0.022	29 x 63 x 12
ME	KL10-10ME	10m x 33ft	10mm	6	24	5	7	0.016	24 x 56 x 12
	KL10-20ME	20m x 66ft				7	9	0.022	29 x 63 x 12
	KL10-30ME	30m x 100ft				12	14	0.022	29 x 63 x 12



# Long Tapes

## Speed Tufmic-12R

"4x Super rewind" Glass fiber long tapes



With the Quad-Speed Tufmic, turn the handle once and the tape rewinds four times!

Tufmic glass-fiber tapes will not stretch or shrink, being resistant to water, humidity, temperature, and most chemicals.

Highly recommended for civil-engineers, land surveyors, and those who insist on quality instruments. [Tape thickness: 0.48mm]

	Cat.No.	Length	Width	QTY/ Inner carton	QTY/ Outer carton	N.W. (kgs)	G.W. (kgs)	M3	Carton size (Cm) D x W x H
QUAD-SPEED REWIND									
Standard tension 20°C 10N									
JIS	SGR12-30	30m	12mm	1	5	5	7	0.027	31 x 33 x 26
	SGR12-50	50m				6	8	0.035	31 x 37 x 31
	SGR12-1H	100m				9	11	0.052	31 x 45 x 37
	SGR12-120	120m				12	14		

## Tufmic-12C/12R

Glass fiber long tapes



Capsule type



Open type

Tufmic glass-fiber tapes will not stretch or shrink, being resistant to water, humidity, temperature, and most chemicals.

Highly recommended for civil-engineers, land surveyors, and those who insist on quality instruments. [Tape thickness: 0.48mm]

	Cat.No.	Length	Width	QTY/ Inner carton	QTY/ Outer carton	N.W. (kgs)	G.W. (kgs)	M3	Carton size (Cm) D x W x H
CAPSULE TYPE									
Standard tension 20°C 10N									
JIS	GK12-10	10m	12mm	1	10	3	5	0.008	14 x 37 x 15
	GK12-20	20m				4	6	0.015	18 x 41 x 20
	GK12-30	30m				5	7	0.020	21 x 43 x 22
OPEN TYPE									
Standard tension 20°C 10N									
JIS	GR12-30	30m	12mm	1	10	3	5	0.029	31 x 41 x 23
	GR12-50	50m				5	7	0.036	34 x 41 x 26
	GR12-1H	100m				5	8	0.028	32 x 38 x 23

## Walking Measure

Walking-Measure is the industry's best choice for quick and easy measuring over a variety of surfaces and it accurately measures while you are walking. One person can measure faster than with a tape measure and you are not limited to length of the tapes.

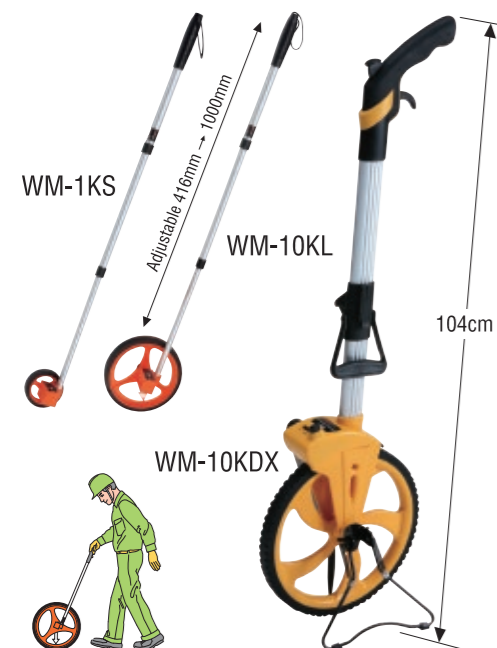

Cat.No.	Min. measuring unit	Max. measuring distance	Wheel dia.	QTY/ Inner carton	QTY/ Outer carton	N.W. (kgs)	G.W. (kgs)	M3	Carton size (Cm) D x W x H
WM-1KS	1cm	1km	10cm	6	12	6	8	0.084	62 x 40 x 34
WM-10KL	10cm	10km	20cm	1	4	8	14	0.154	36 x 67 x 64
WM-10KDX			32cm						



### Low-friction, extruded nylon coated Stainless steel tape

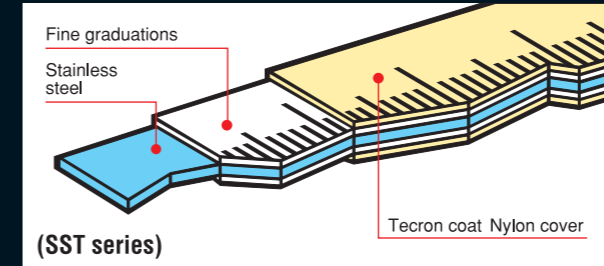

### Low-friction, extruded nylon coated steel tape

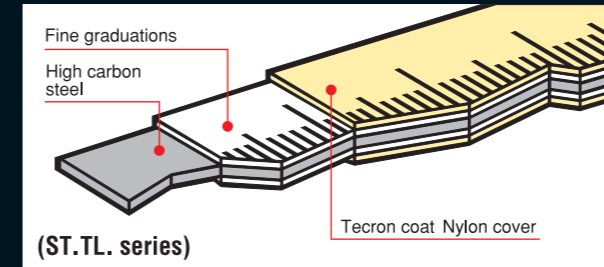

### Low-friction, steel tape

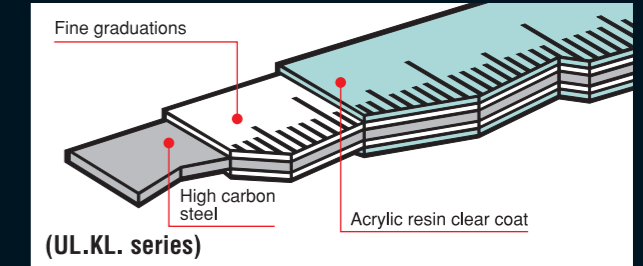

### Glass-fiber tape

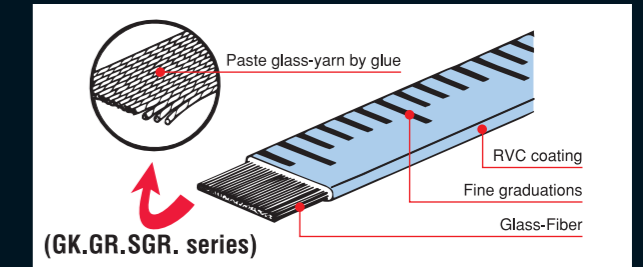

# Long Tapes Marking specifications and graduations

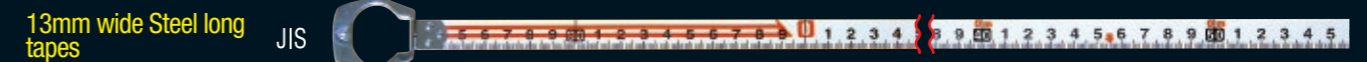
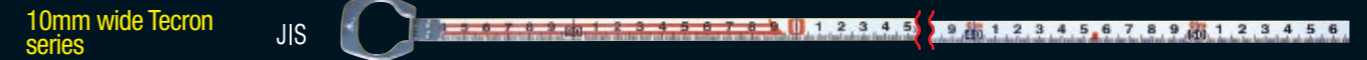

### ZERO point manner

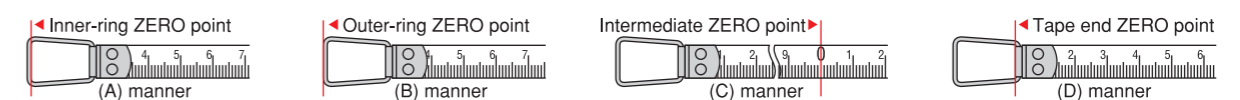



## Long Tapes packaging

Name	Graduation	Cat. No.	Length	Width	QTY/Inner carton 	QTY/Outer carton 			
Speed Tecron-10		SST10-30	30m	10mm					
		SST10-50	50m						
Speed Tecron-13 		ST13-30	30m	13mm					
		ST13-50	50m						
Tecron-13 	JIS	TL13-30	30m	13mm		1			
		TL13-50	50m						
Unilong-13 		UL13-30	30m	13mm					
		UL13-50	50m						
Kaclong-10 		KL10-10	10m	10mm		6			
		KL10-20	20m						
		KL10-30	30m						
	ME	KL10-10ME	10m x 33ft.					Packed 4 inner cartons	24
		KL10-20ME	20m x 66ft.						
		KL10-30ME	30m x 100ft.						
Speed Tufmic-12R 		SGR12-30	30m	12mm		1			
		SGR12-50	50m						
		SGR12-1H	100m						
		SGR12-120	120m						
Tufmic-12C 	JIS	GK12-10	10m	12mm		1			
		GK12-20	20m						
		GK12-30	30m						
Tufmic-12R 		GR12-30	30m	12mm		10			
		GR12-50	50m						
		GR12-1H	100m						
						Packed 10 inner cartons			
						Packed 5 inner cartons			

## Electronic Products

### Tracking Gauge



KDS Tracking Gauge TG-39 is a novel product, equipped with a transparent type optical sensor and a customized micro-computer, providing a digitally displayed tracking gauge that is especially effective in measuring the dimensions of a vehicle body and frame when being realigned.

Detection	Transparent Type Photo-Interrupter
Accuracy	±3 mm Including a Quantization Error
Min. unit:	0.001m (1 mm)
Measurement Range	In: 0.315 - 3.200 m Out: 1.050 - 3.900 m
Function	Stopping device for each pole, Stop lever in last pole, Zero-set, Hold, <b>10 Memory reference</b> , Memory input, Display backlight, Selection of measuring unit, Inverse, Selection of automatic power-off, Memory clear
Power	4 pieces of R6 or LR6 Battery
Battery Life	<b>About 45 hours</b> in normal continuous use (Manganese Batteries are used)
Operable Temperature	0 to 40°C Celsius
Weight ( Main Unit and Batteries )	1.7 kg
Dimensions	1,000 (L) × 44 (W) × 73 (H)
Accessories( Included )	Carrying Case, Four R6 Batteries, Two Holders, Three Types of Tip Attachment

The Digital Tracking Gauge, designed for use in automotive body work.

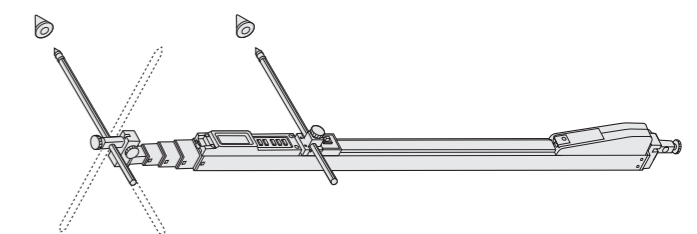
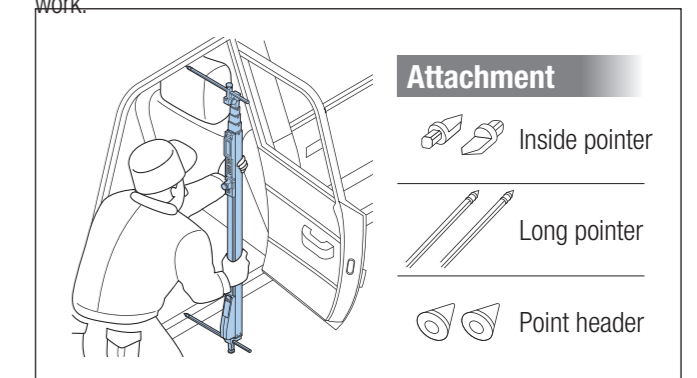

Cat.No.	Inner (pcs.)	Outer (pcs.)	N.W. (kgs)	G.W. (kgs)	M3	Carton size (Cm) D x W x H
TG-39	1	2	4	6	0.021	12 x 104 x 17

## Electronic Products

### Digital Pole Measures



Digital Pole Measures are an excellent way to measure diagonal and inside length.

Six sectional measuring rod with 10 memories.

Cat.No.	Inner (pcs.)	Outer (pcs.)	N.W. (kgs)	G.W. (kgs)	M3	Carton size (Cm) D x W x H
DM-20	1	4	5	7	0.024	25 x 60 x 16
DM-40			7	9	0.038	25 x 93 x 16
DM-50			9	11	0.045	25 x 110 x 16
DM-60			10	12	0.051	25 x 127 x 16

### Digital Pole Measures-S



Simple model of Digital Pole Measures without memory function.

Each of telescoping rods provide accurate measurement and display.

Cat.No.	Inner (pcs.)	Outer (pcs.)	N.W. (kgs)	G.W. (kgs)	M3	Carton size (Cm) D x W x H
DMN-40	1	4	7	9	0.038	25 x 93 x 16
DMN-50			9	11	0.045	25 x 110 x 16

Pole-type measure makes your work easy!

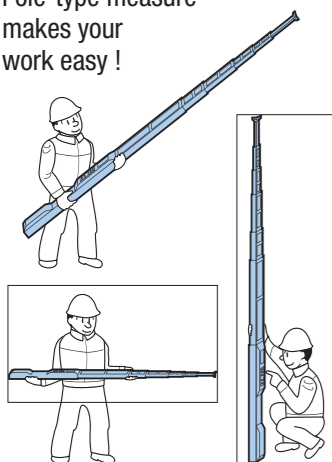

Cat. No.	DM-20	DM-40	DM-50	DM-60	DMN-40	DMN-50
Min. length	0.550m	0.880m	1.050m	1.220m	0.880m	1.050m
Max. length	2.000m	4.000m	5.000m	6.000m	4.000m	5.000m
Outside dimension	550 X 44 X 73mm	880 X 44 X 73mm	1050 X 44 X 73mm	1220 X 44 X 73mm	880 X 44 X 73mm	1050 X 44 X 73mm
Weight	1.2kg	1.7kg	1.95kg	2.2kg	1.7kg	1.95kg
Detection	Transmissive Photo Interrupter					
Accuracy	±2mm(including quantization error)					
Min. unit	0.001m (1 mm)					
Display	Digital 6 digit, LCD display					
Operable Temperature	0 to 40°C Celsius					
Power	4 pieces of R6 or LR6 Battery					
Battery life	About 45 hours in normal continuous use (Manganese Batteries are used)					
Accessories	Exclusive carrying case, 4 pieces of R6 battery, Instruction Manual					
<b>Function</b>						
Memory references	10 memory				no	
Stopping device of each pole					Yes	
Stop lever in last pole					Yes	
Zero-set					Yes	
Hold (Temporary hold of displayed value)					Yes	
Inverse	Yes				no	
Automatic power saving	5 min, 30 min and cancellation				5 min	
Selection of measuring unit	Metric, inch, Sixteenths(1/16) and 10THS/100THS of feet				Metric only	
Display backlight	Yes					

## Wooden Chisels / Planers



### Wooden Chisels



KDS chisel blade and tang are made from carbon steel and are tempered and beveled, with a tough, impact - resistant plastic handle. Available in standard tang, and in eight special types for crafts, wood carving, and other elaborate work.

Long Type						
Cat.No.	Width	CTN(Unit.)	N.W.(kgs)	G.W.(kgs)	M3	
EN-01BP	6mm	60	14	16	0.033	
EN-015BP	9mm	60	15	17	0.033	
EN-02BP	12mm	60	16	18	0.033	
EN-025BP	15mm	60	11	12	0.044	
EN-03BP	19mm	60	11	12	0.044	
EN-035BP	22mm	60	12	14	0.044	
EN-04BP	25mm	60	13	15	0.044	
EN-05BP	32mm	60	15	17	0.044	
EN-06BP	38mm	60	17	19	0.044	
EN-3SV	12, 19, 25mm	48 set	26	28	0.042	
EN-4SV	6, 12, 19, 25mm	32 set	22	24	0.038	
EN-6SV	6, 12, 15, 19, 25, 32mm	24 set	27	29	0.049	
Special type						
Cat.No.	Type	Width	CTN(Unit.)	N.W.(kgs)	G.W.(kgs)	M3
No.3101	flat	9mm	100	10	12	0.041
No.3103	flat	15mm	100	10	12	0.041
No.3104	shallow gouge	9mm	100	10	12	0.041
No.3105	gouge	9mm	100	10	12	0.041
No.3106	gouge	12mm	100	10	12	0.041
No.3107	v-parting	9mm	100	10	12	0.041
No.3108	bent gouge	9mm	100	10	12	0.041
No.3109	skew	9mm	100	10	12	0.041
No.3166	6pce. Set		24 set	15	17	0.050
	No.3101, No.3103, No.3105, No.3106, No.3107, No.3109					
No.3168	8pce. Set		24 set	21	23	0.067
	No.3101, No.3103, No.3104, No.3105, No.3106, No.3107, No.3108, No.3109					



### Planers



KDS brand planes are made from high grade carbon steel with a Japanese white oak body. No. 5710 is for chamfer molding, No. 5720 is for round molding, and No. 5730 is for micro planing. Blades are replaceable and can be sharpened. Available in various widths for elaborate work. Only in Japanese versions.

Cat.No.	Blade	CTN(Unit.)	N.W.(kgs)	G.W.(kgs)	M3
No.5710	30mm	60	18	20	0.047
No.5720	30mm	60	14	16	0.033
No.5730	30mm	60	14	16	0.033
No.5742	42mm	30	11	13	0.023
No.5748	48mm	30	15	17	0.024
No.5750	50mm	20	15	17	0.024
No.5758	58mm	20	19	21	0.003
No.5760	60mm	20	19	21	0.003